

Clash Publish



Clash Computation Specification			
Products Selected		Value	Status
NTB_0004-0008-OpenEnvelope - OPEN ENVELOPE OF CRYORING, ALL SECTORS	AT602154MQ Sec4 - MUON BARREL CHAMBERS DETAILED, SECTOR 4	-50.5 mm	Not inspected
	AT602154MQ Sec6 - MUON BARREL CHAMBERS DETAILED, SECTOR 6	-50.5 mm	Not inspected
	AT602154MQ - MUON BARREL CHAMBERS DETAILED, SECTOR 2	-50.5 mm	Not inspected
	AT602159MQ - MUON BARREL CHAMBERS DETAILED, SECTOR 8	-50.5 mm	Not inspected
	AT602164MQ - MUON BARREL CHAMBERS DETAILED, SECTOR 12	-50.5 mm	Not inspected
	AT602166MQ - MUON BARREL CHAMBERS DETAILED, SECTOR 14	-50.5 mm	Not inspected
	AT602168MQ - MUON BARREL CHAMBERS DETAILED, SECTOR 10	-50.5 mm	Not inspected
	AT602342MQ - MUON BARREL CHAMBERS DETAILED, SECTOR 16	-50.5 mm	Not inspected
	NMA__0001 - BARREL PROJECTIVE ALIGNMENT. - SIMPLE 3-D MODEL. SECTOR 1	-119 mm	Not inspected
	NMA__0004 - BARREL PROJECTIVE ALIGNMENT. - SIMPLE 3-D MODEL. SECTOR 7	-119 mm	Not inspected
	NMA__0005 - BARREL PROJECTIVE ALIGNMENT. - SIMPLE 3-D MODEL. SECTOR 9	-19 mm	Not inspected
	NMA__0006 - BARREL PROJECTIVE ALIGNMENT. - SIMPLE 3-D MODEL. SECTOR 11	-19 mm	Not inspected
	NMA__0008 - BARREL PROJECTIVE ALIGNMENT. - SIMPLE 3-D MODEL. SECTOR 15	-19 mm	Not inspected
	NSR__0007 - TB CABLE SERVICE - CABLE TRAYS	-128.7 mm	Not inspected

Computation Result:

NTB_0004-0008-OpenEnvelope - OPEN
ENVELOPE OF CRYORING, ALL SECTORS

AT602154MQ Sec4 - MUON BARREL CHAMBERS
DETAILED, SECTOR 4

Clash

-50.5 mm

Not inspected

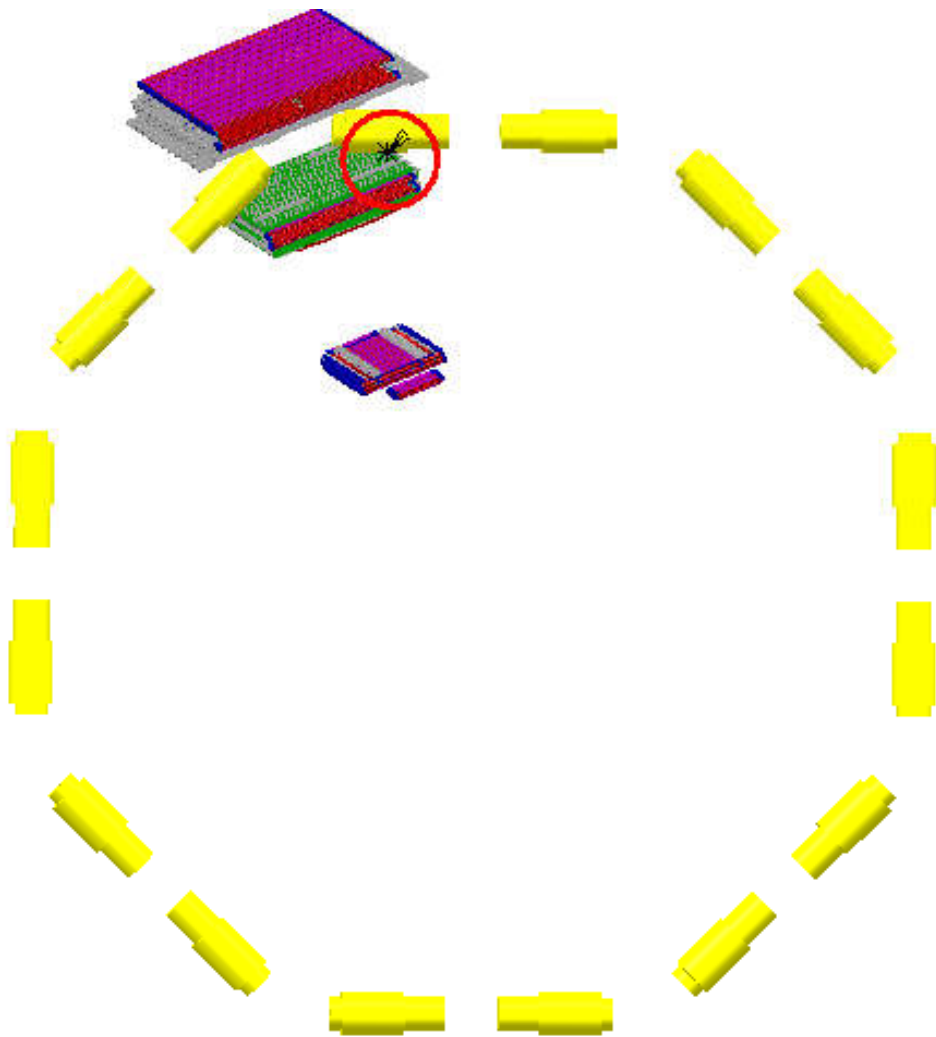

Clash value: ~ 50.5 mm

SIDE C

Sector 4

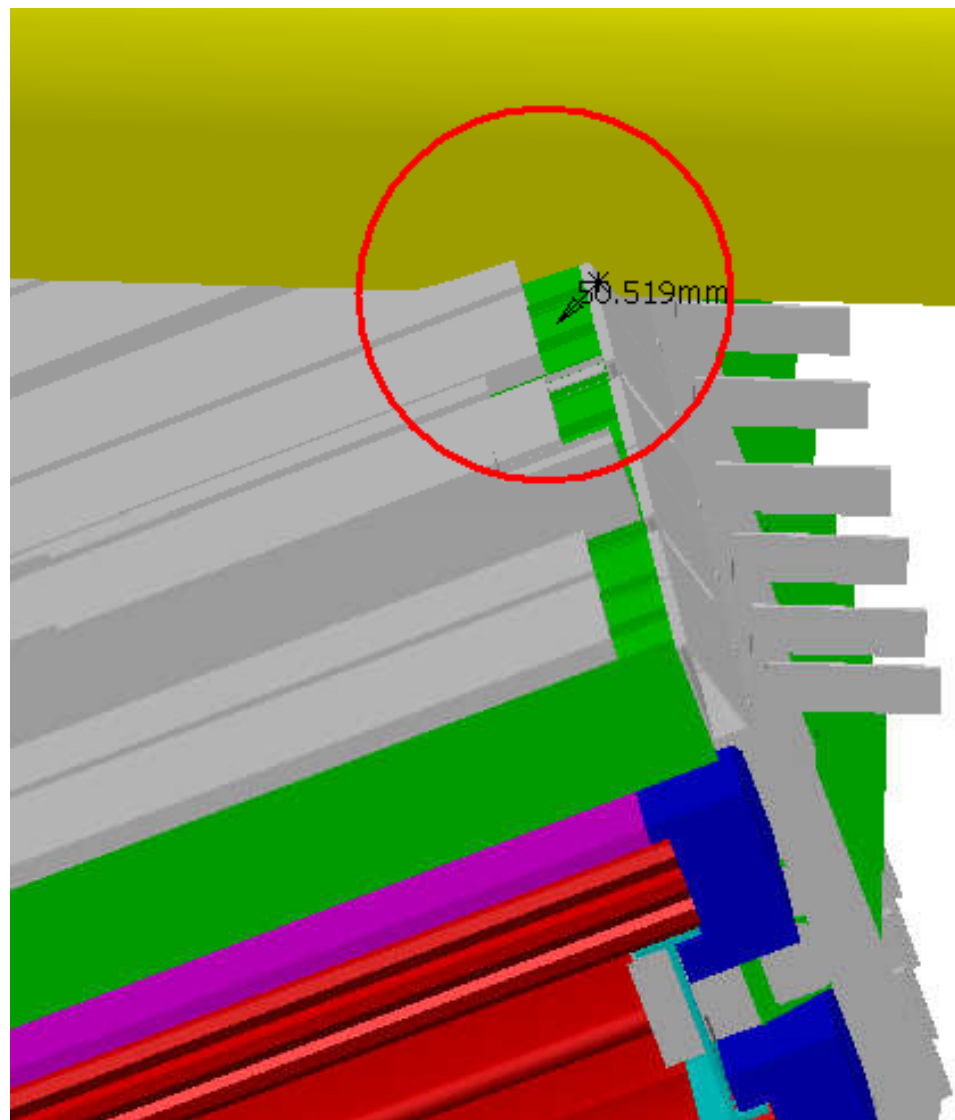

NTB_0004-0008-OpenEnvelope - OPEN
ENVELOPE OF CRYORING, ALL SECTORS

AT602154MQ Sec6 - MUON BARREL
CHAMBERS DETAILED, SECTOR 6

Clash

-50.5 mm

Not inspected

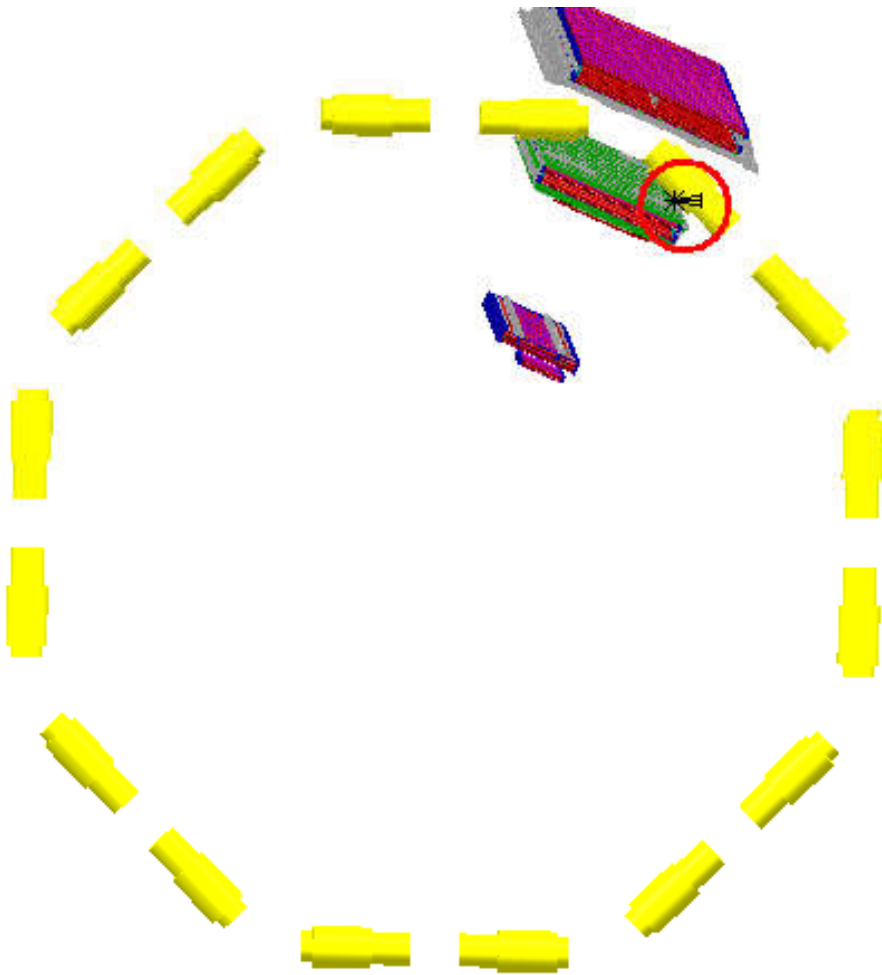

Clash value: ~ 50.5 mm

SIDE C

Sector 6

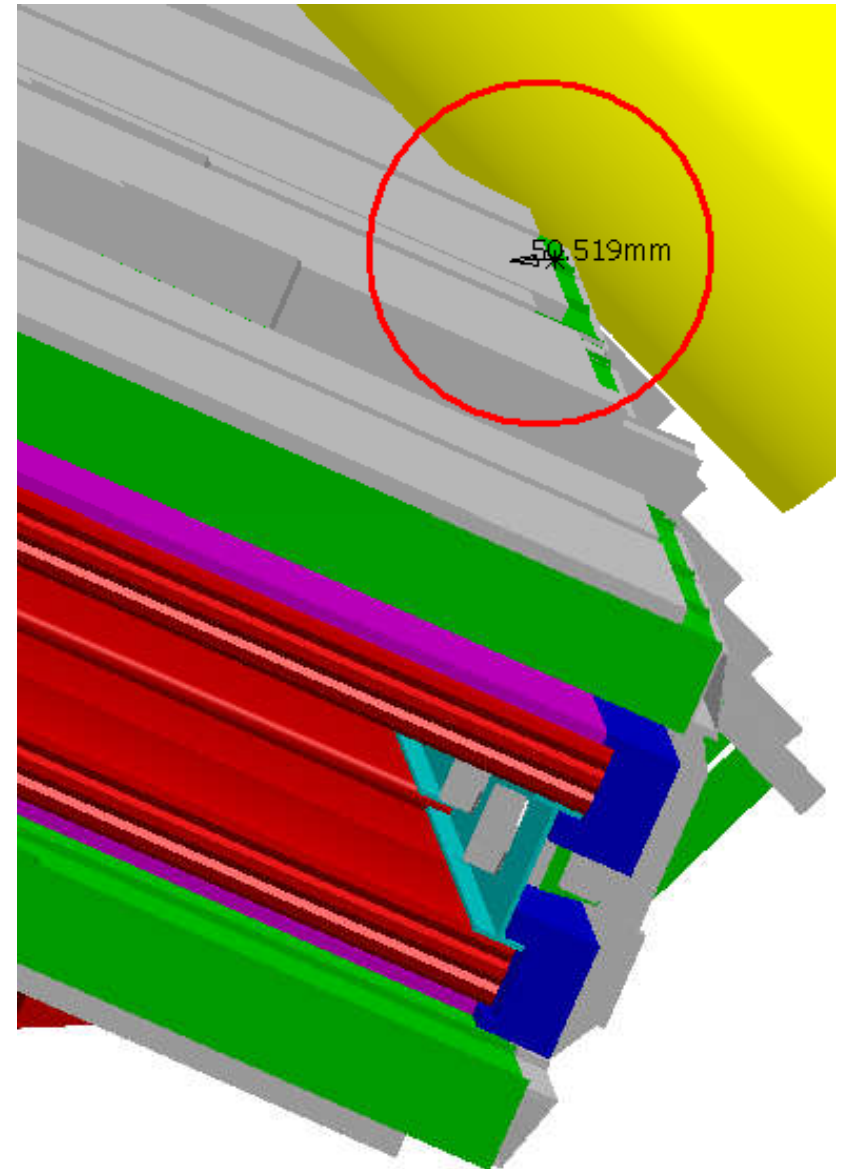

NTB_0004-0008-OpenEnvelope - OPEN
ENVELOPE OF CRYORING, ALL SECTORS

AT602154MQ - MUON BARREL CHAMBERS
DETAILED, SECTOR 2

Clash

-50.5 mm

Not inspected

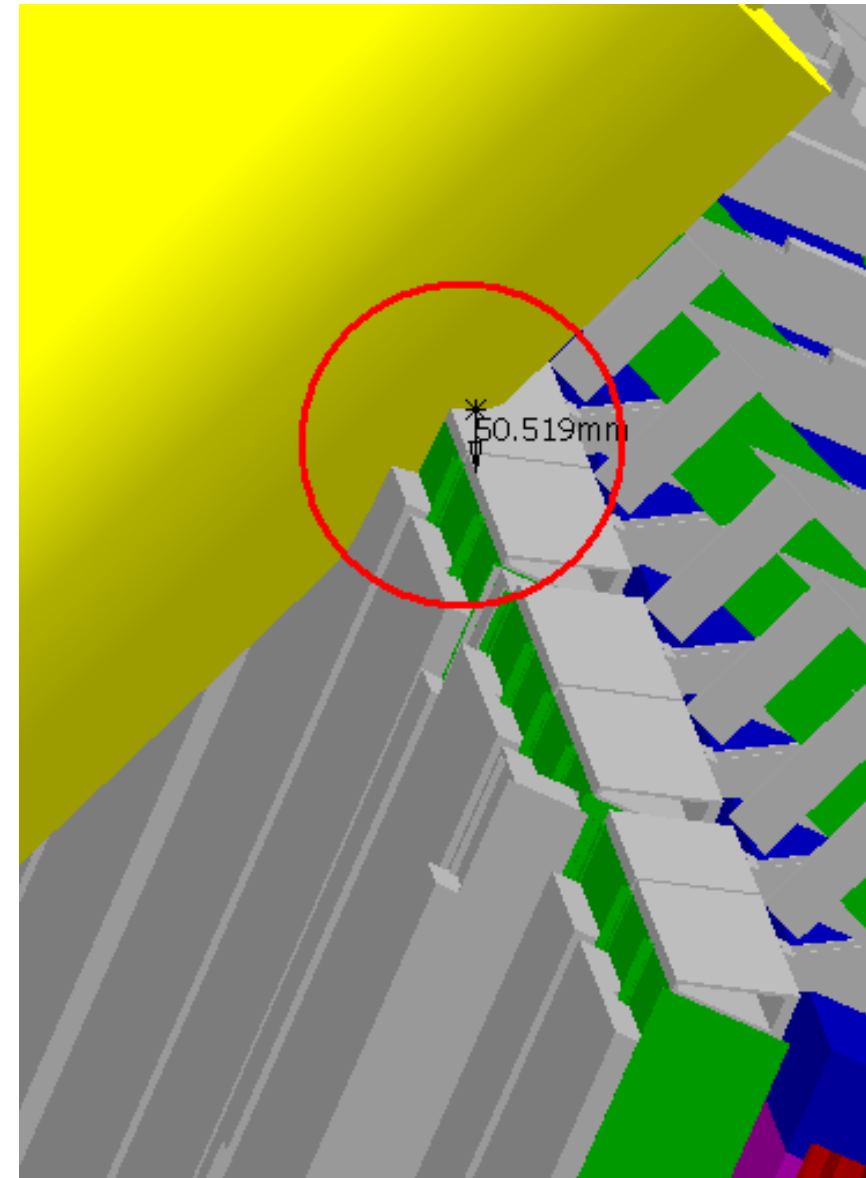
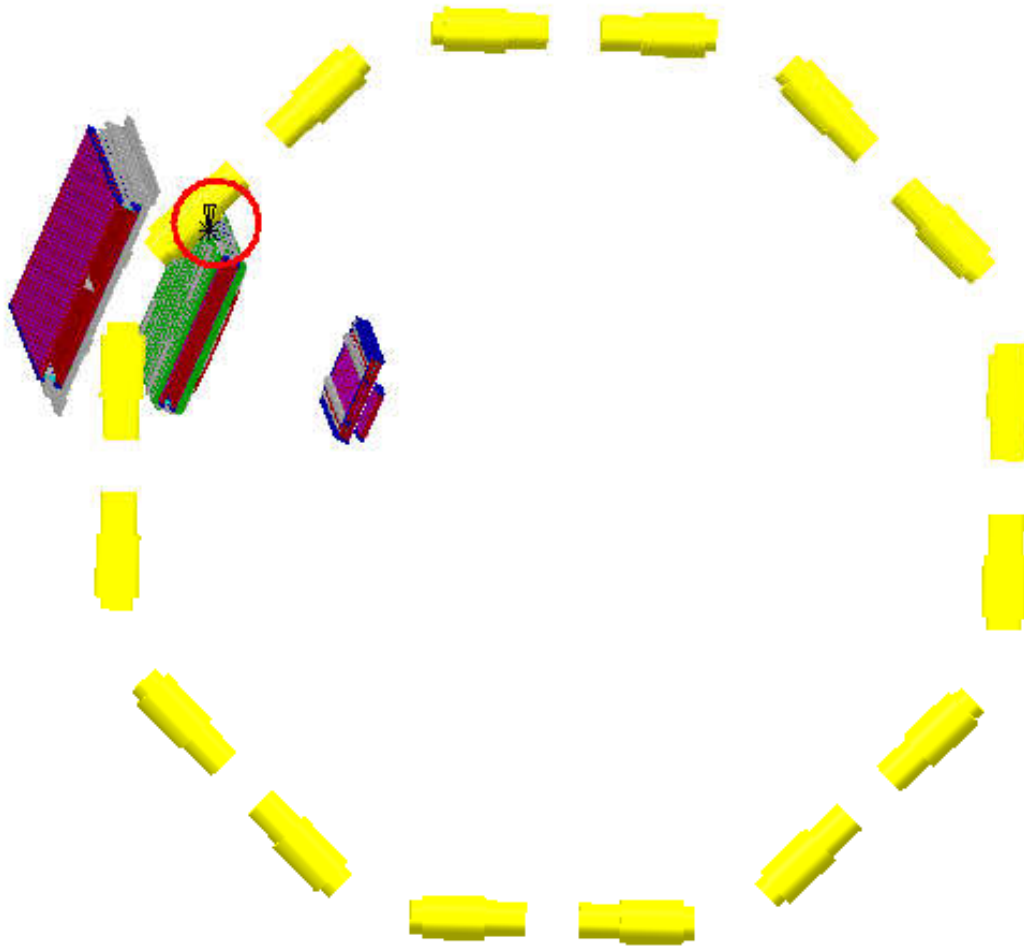

Clash value: ~ 50.5 mm

SIDE C

Sector 2

NTB_0004-0008-OpenEnvelope - OPEN
ENVELOPE OF CRYORING, ALL SECTORS

AT602159MQ - MUON BARREL CHAMBERS
DETAILED, SECTOR 8

Clash

-50.5 mm

Not inspected

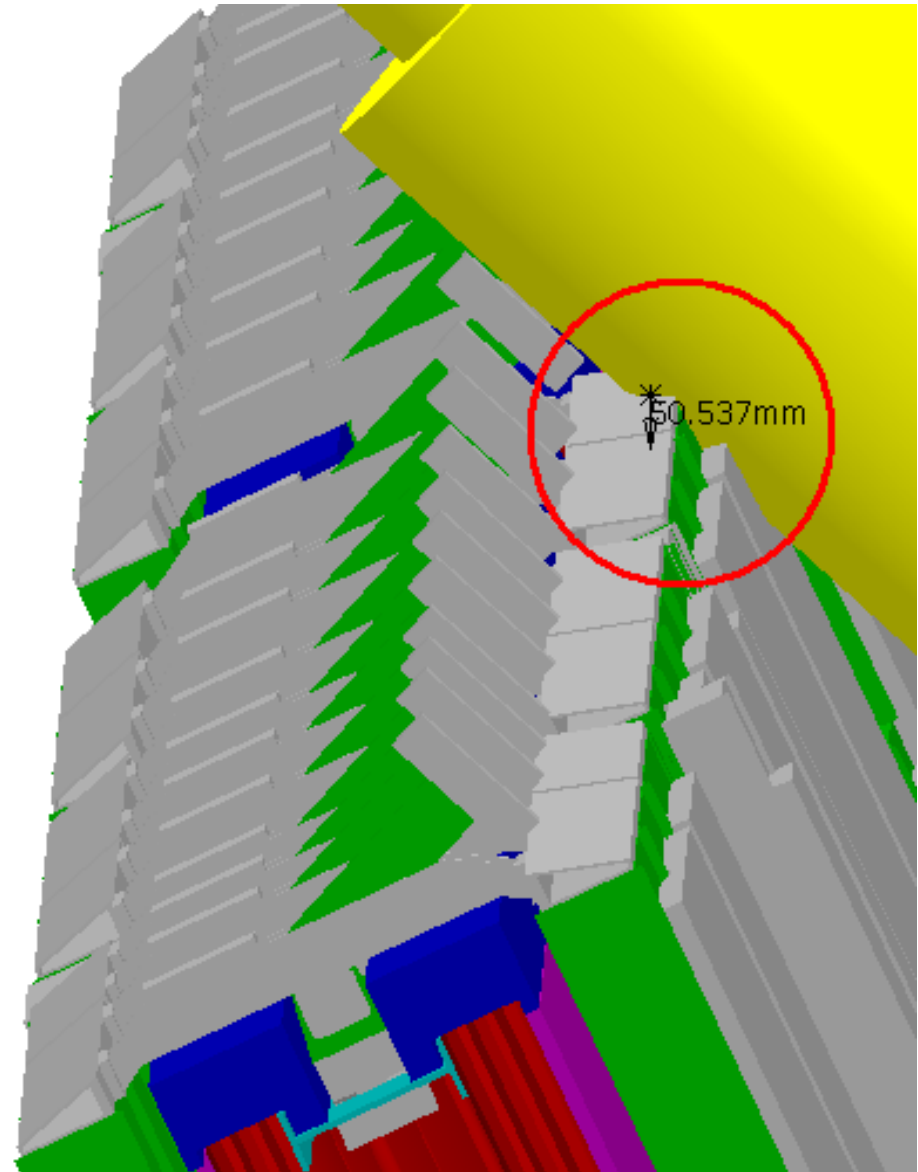
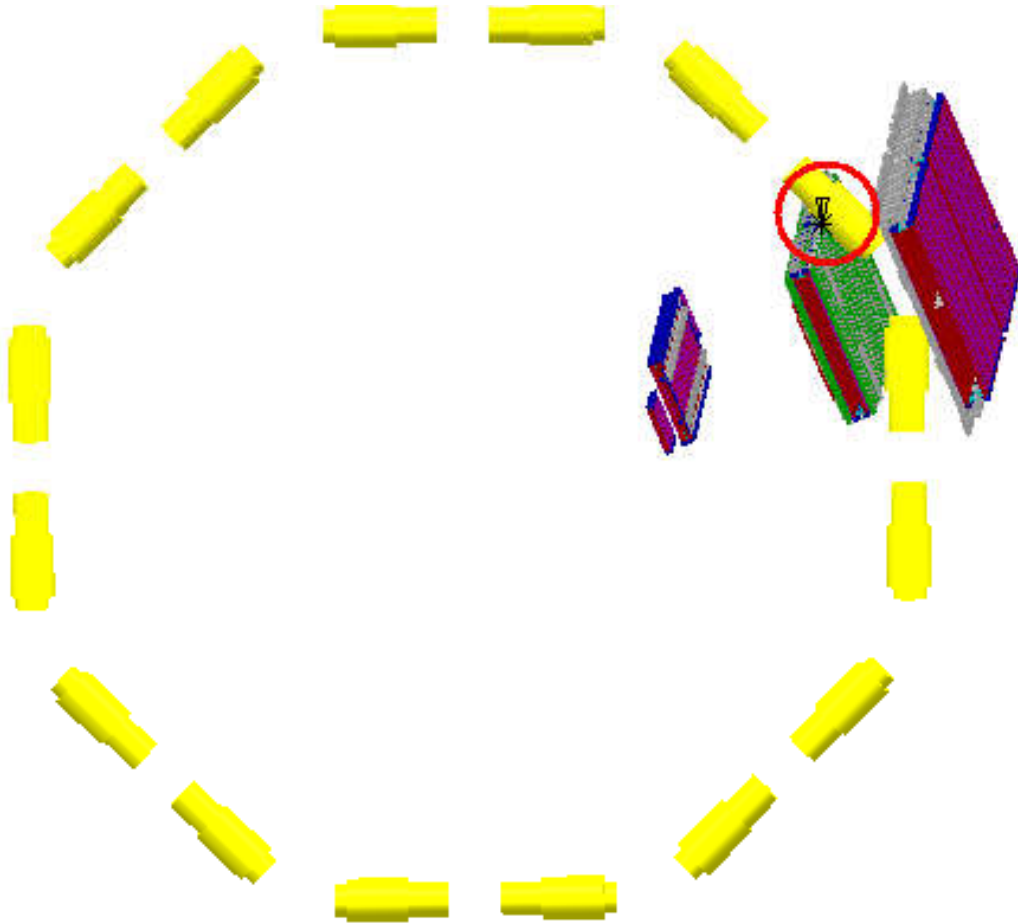

Clash value: ~ 50.5 mm

SIDE C

Sector 8

NTB_0004-0008-OpenEnvelope - OPEN
ENVELOPE OF CRYORING, ALL SECTORS

AT602164MQ - MUON BARREL CHAMBERS
DETAILED, SECTOR 12

Clash

-50.5 mm

Not inspected

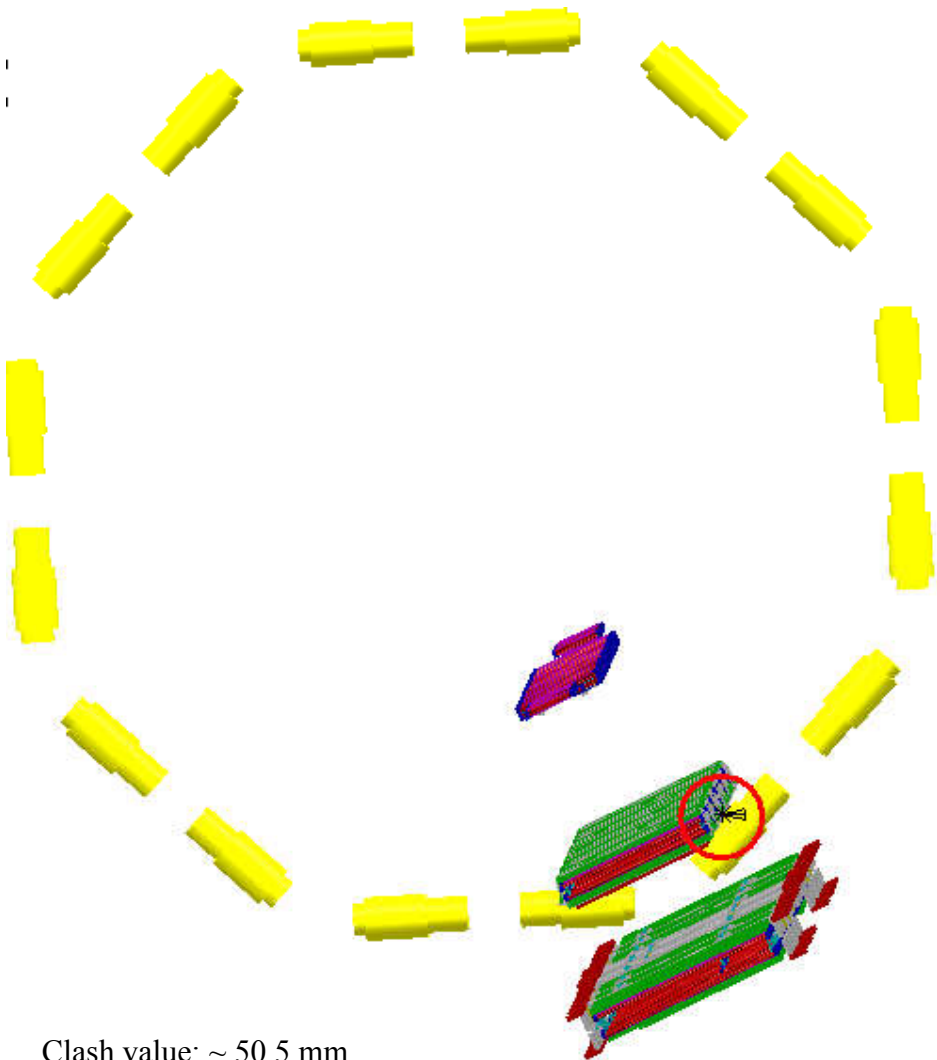

Clash value: ~ 50.5 mm

SIDE C

Sector 12

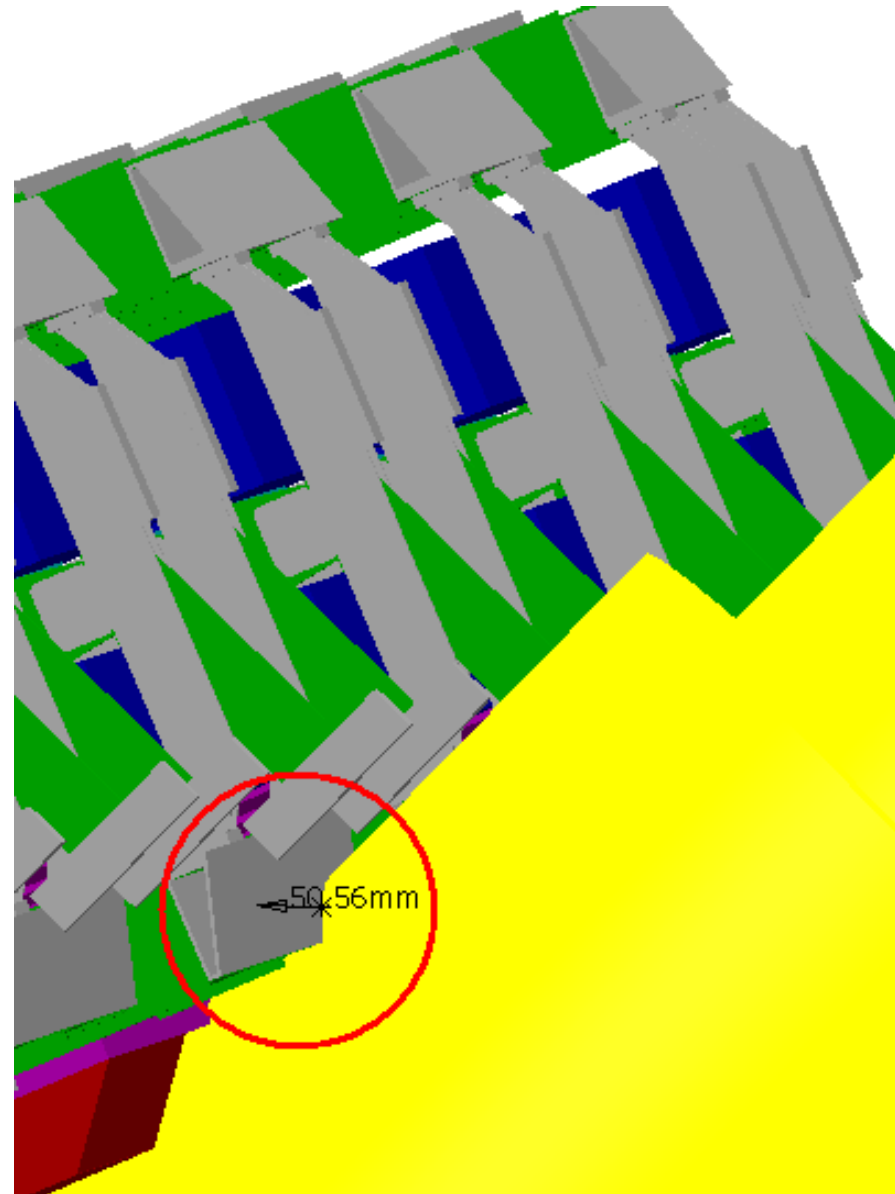

NTB_0004-0008-OpenEnvelope - OPEN
ENVELOPE OF CRYORING, ALL SECTORS

AT602166MQ - MUON BARREL CHAMBERS
DETAILED, SECTOR 14

Clash

-50.5 mm

Not inspected

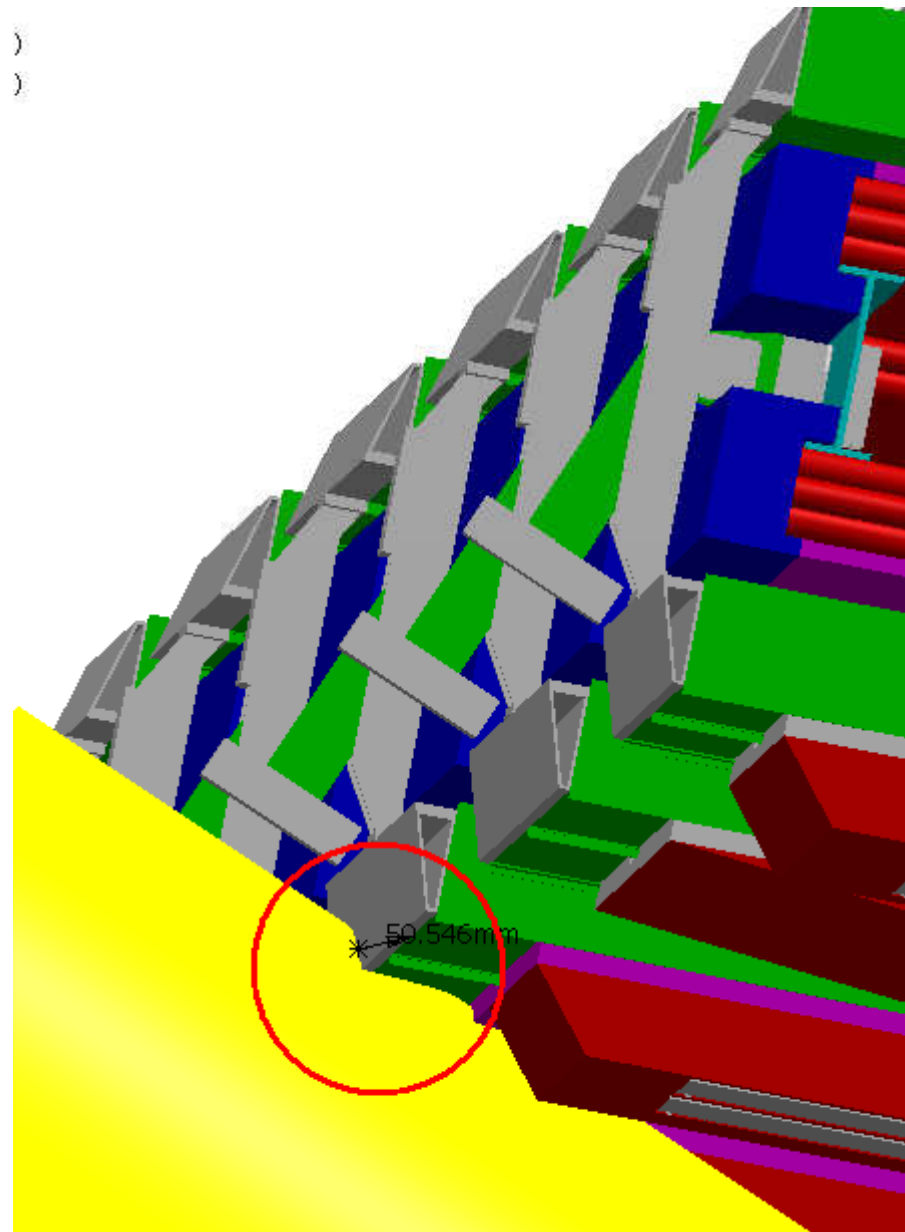
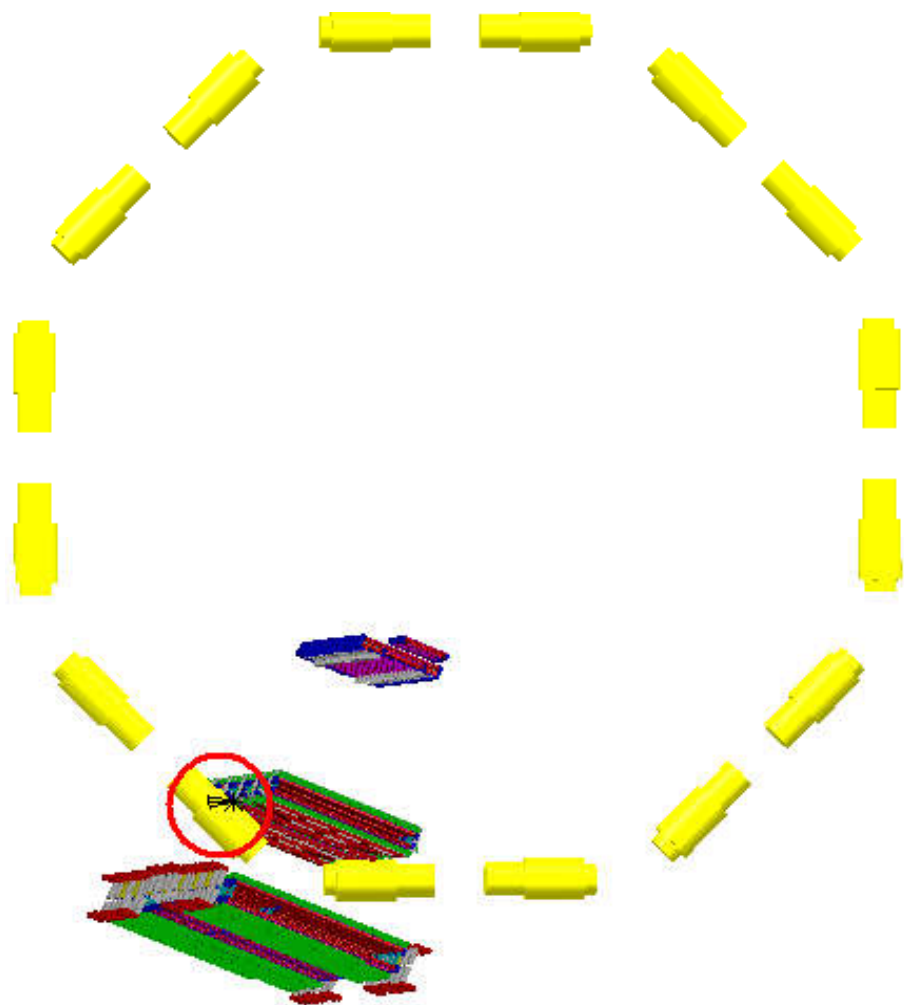

Clash value: ~ 50.5 mm

SIDE C

Sector 14

NTB_0004-0008-OpenEnvelope - OPEN ENVELOPE OF CRYORING, ALL SECTORS

AT602168MQ - MUON BARREL CHAMBERS DETAILED, SECTOR 10

Clash

-50.5 mm

Not inspected

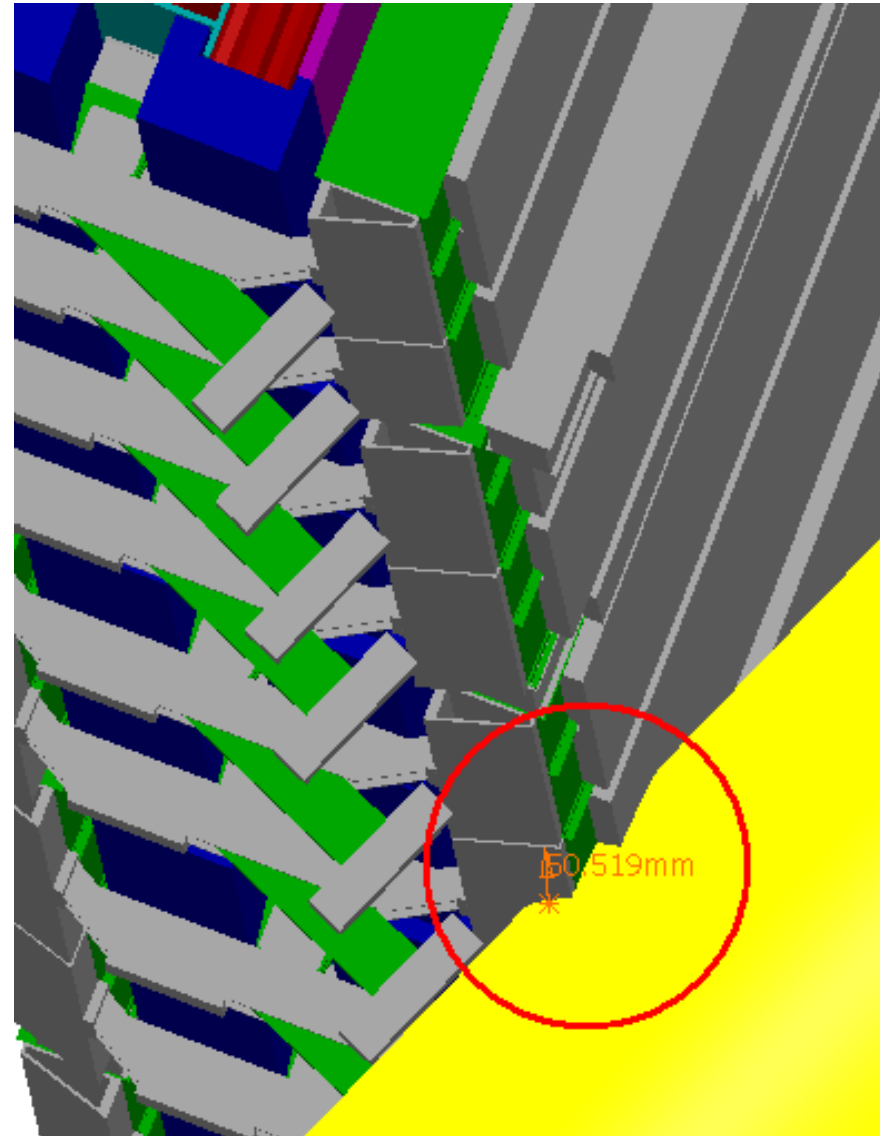
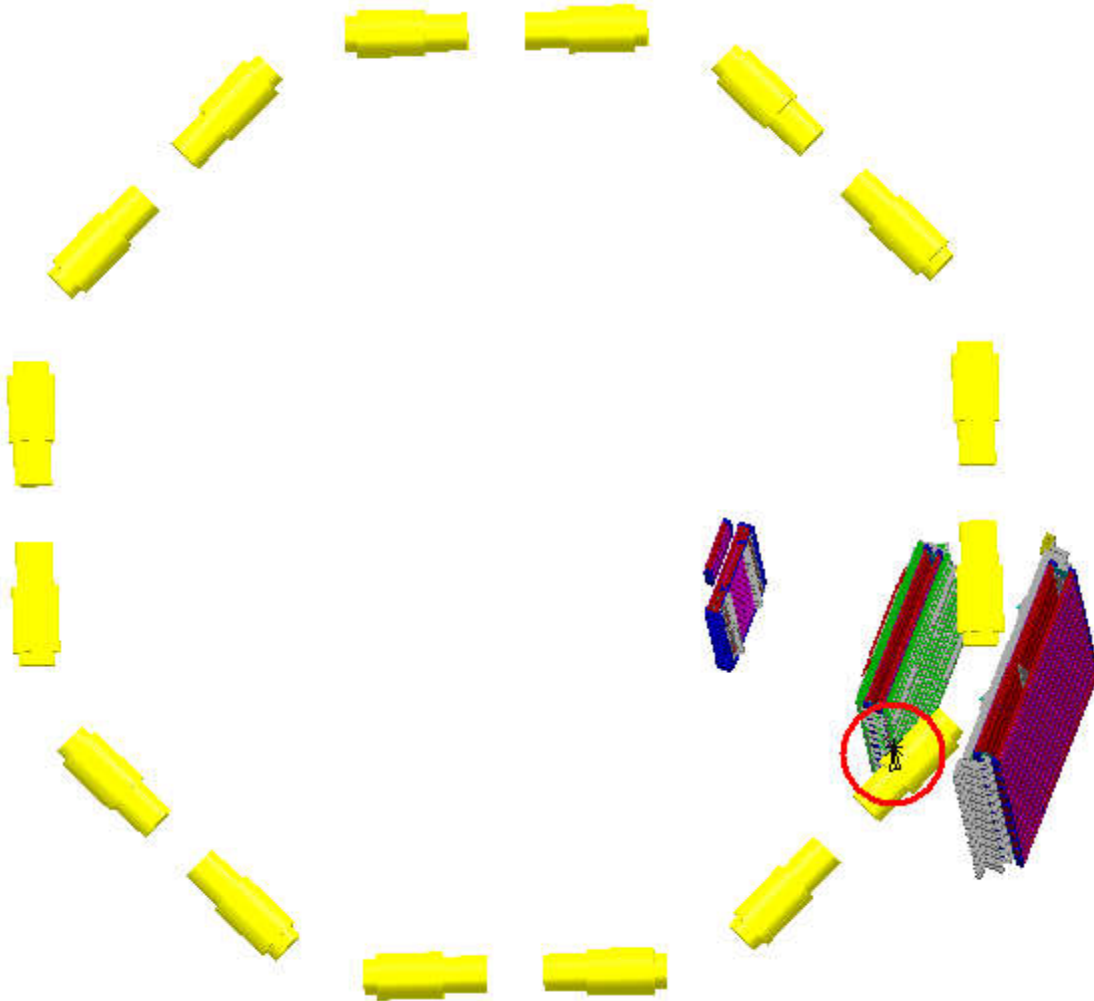

Clash value: ~ 50.5 mm

SIDE C

Sector 10

NTB_0004-0008-OpenEnvelope - OPEN ENVELOPE OF CRYORING, ALL SECTORS	AT602342MQ - MUON BARREL CHAMBERS DETAILED, SECTOR 16	Clash	-50.5 mm	Not inspected
---	---	-------	----------	---------------

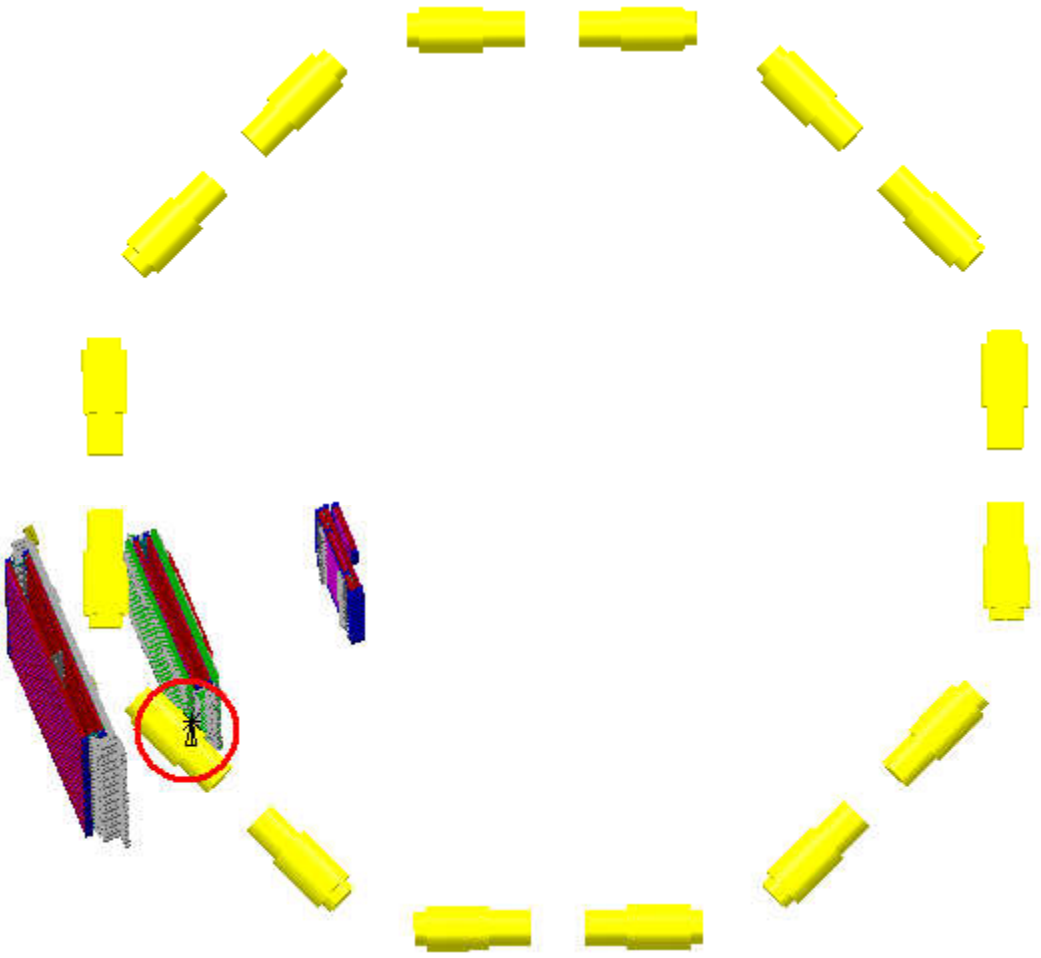

Clash value: ~ 50.5 mm
SIDE C
Sector 16

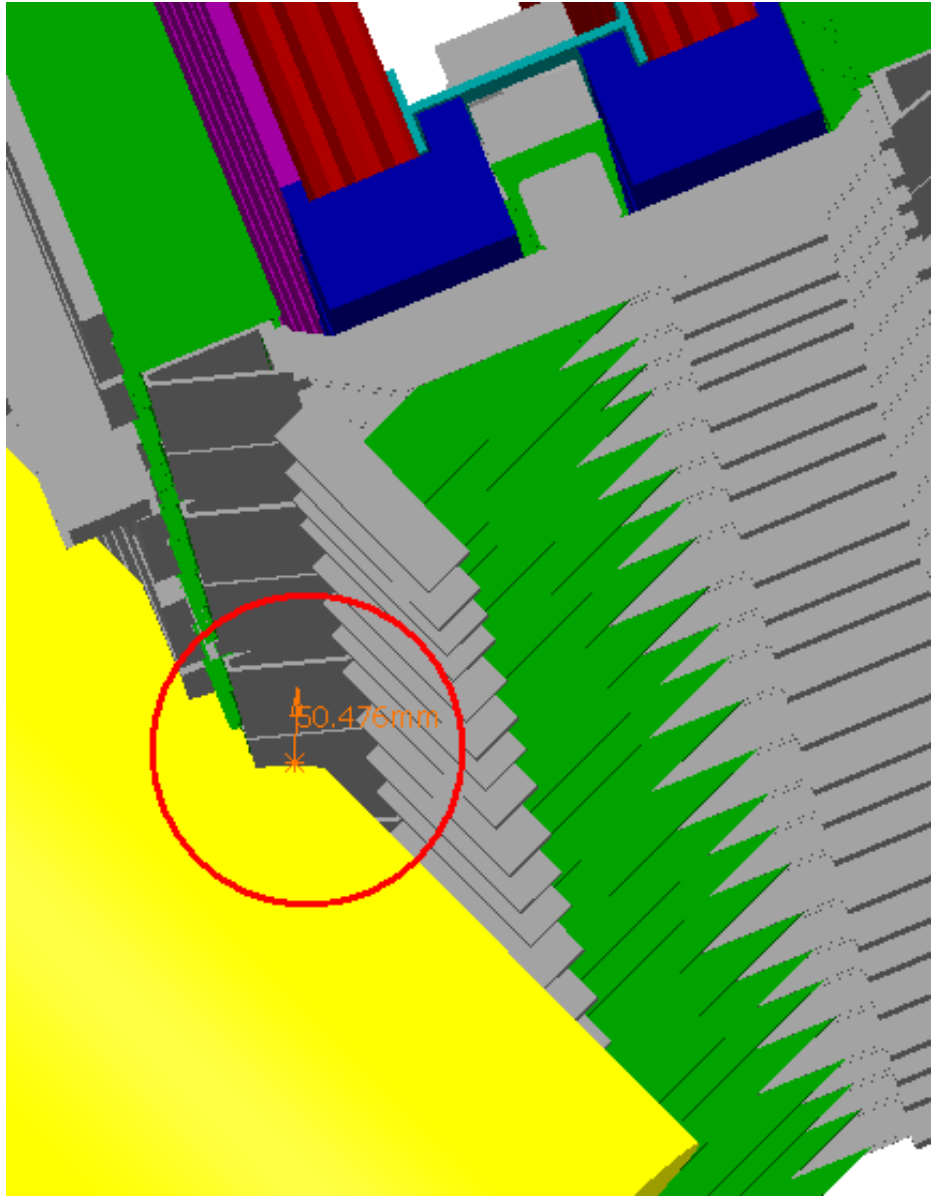

NTB_0004-0008-OpenEnvelope - OPEN
ENVELOPE OF CRYORING, ALL SECTORS

NMA_0001 - BARREL PROJECTIVE
ALIGNMENT. - SIMPLE 3-D MODEL. SECTOR 1

Clash

-119 mm

Not inspected

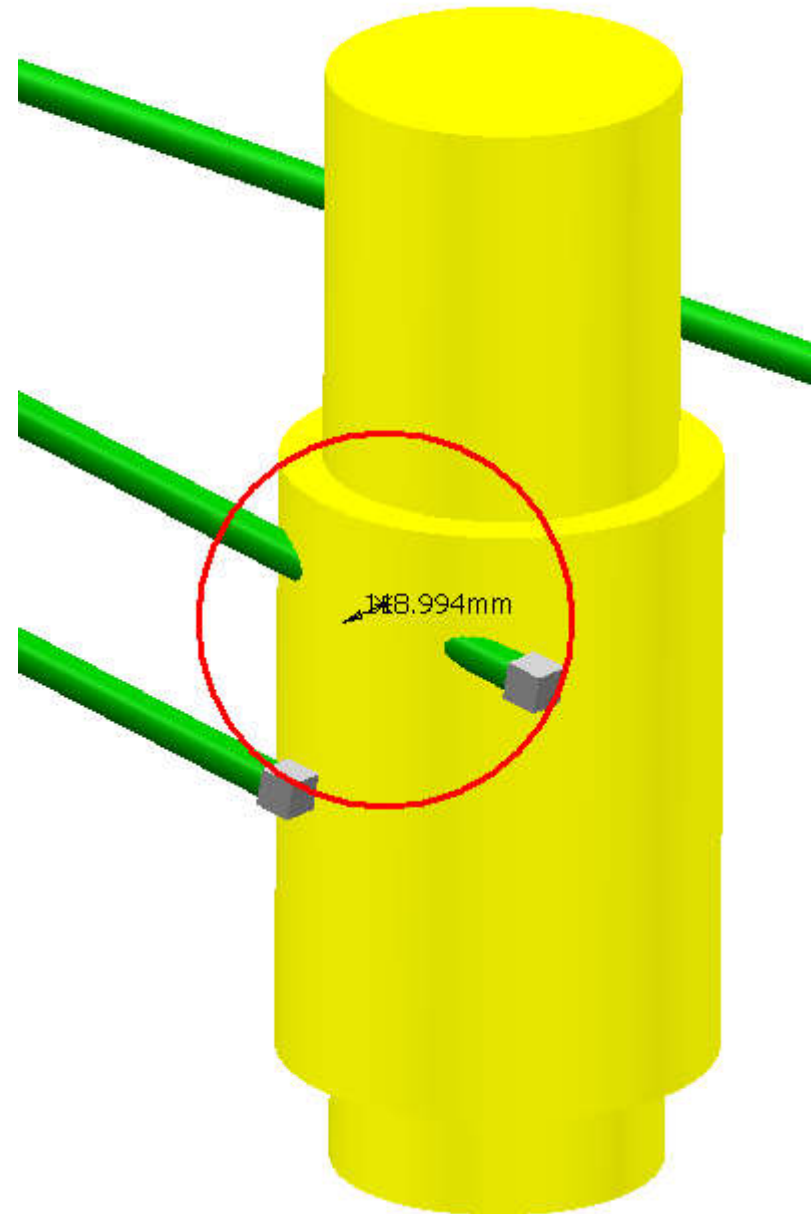
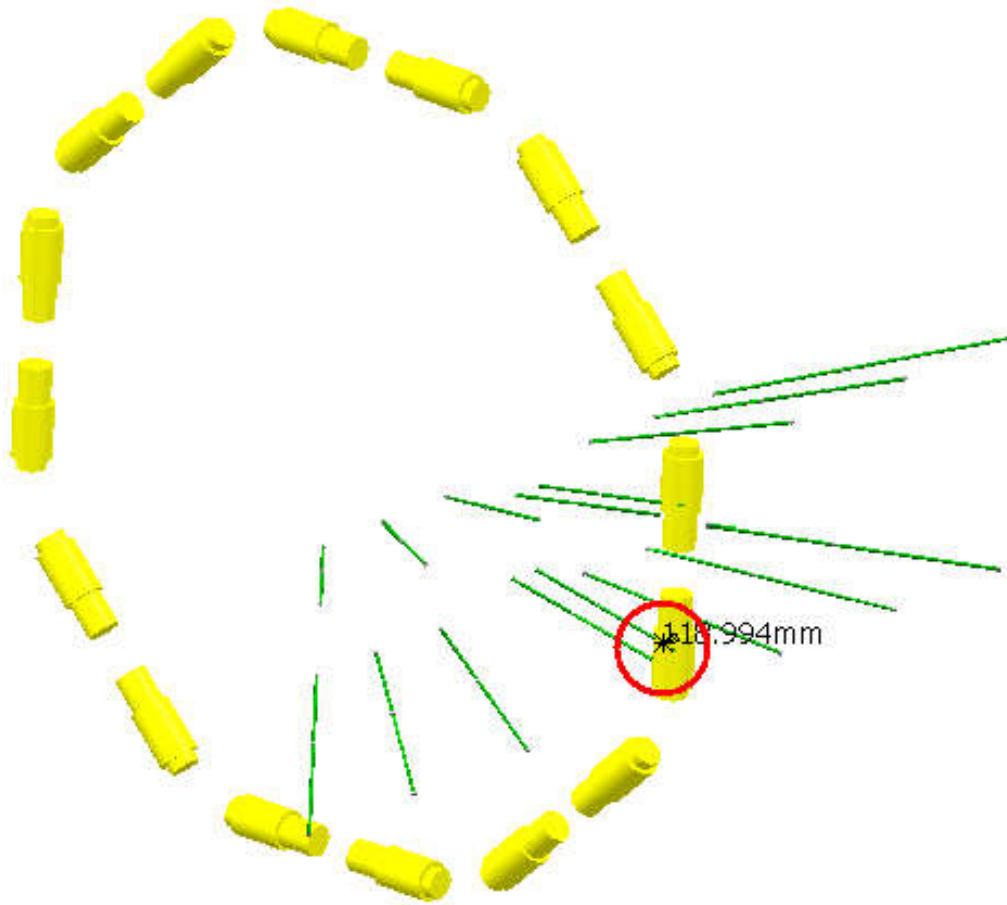

Clash value: ~ 119 mm

SIDE C

Sector 1

NTB_0004-0008-OpenEnvelope - OPEN
ENVELOPE OF CRYORING, ALL SECTORS

NMA_0004 - BARREL PROJECTIVE
ALIGNMENT. - SIMPLE 3-D MODEL. SECTOR 7

Clash

-119 mm

Not inspected

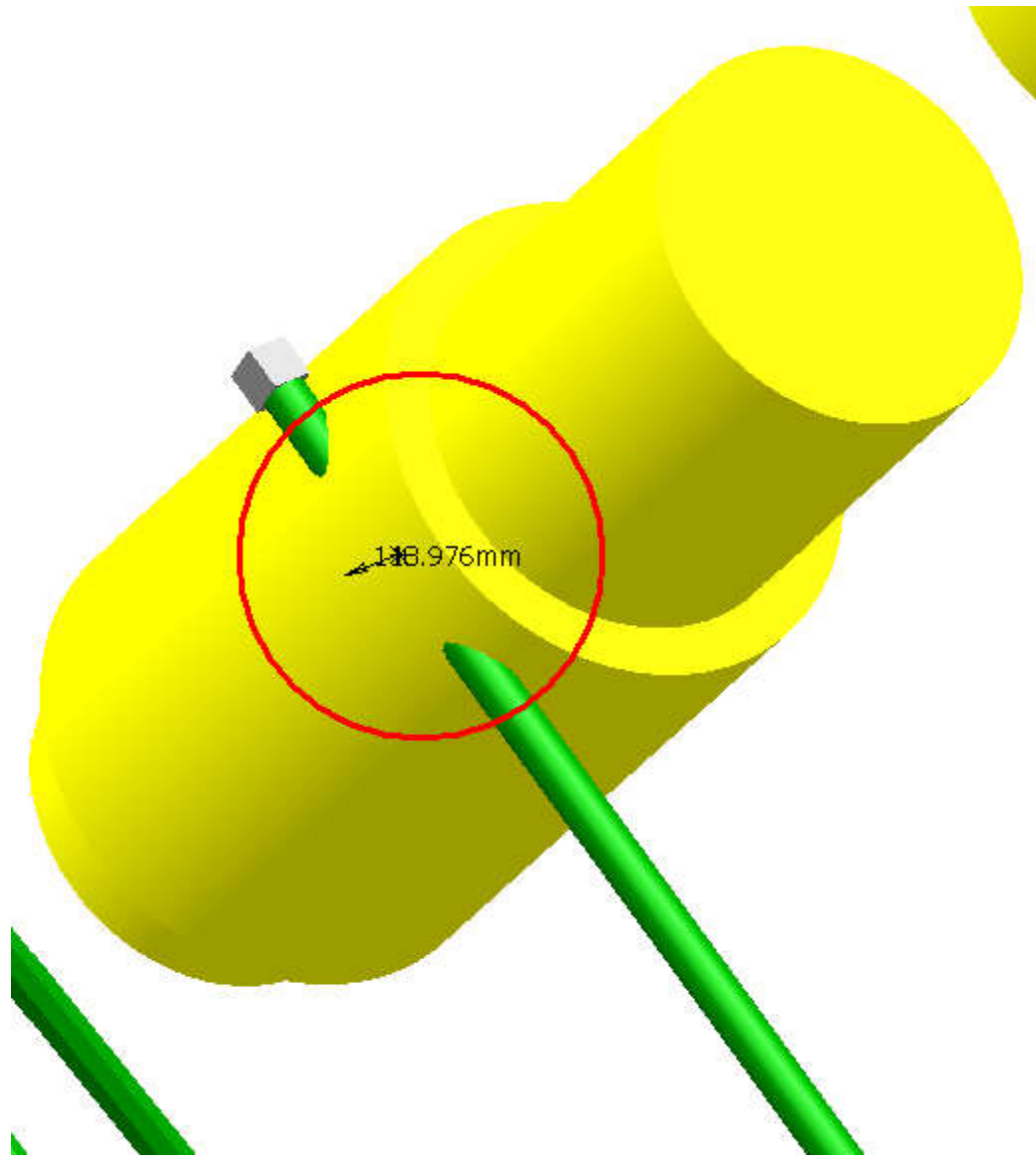
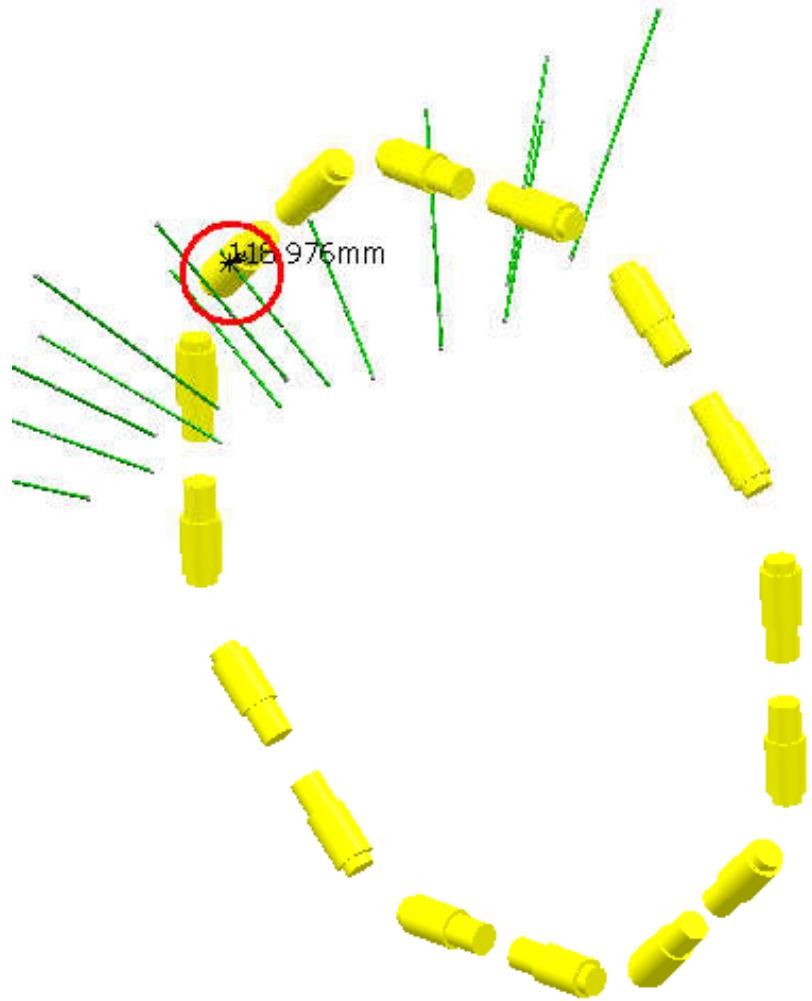

Clash value: ~ 119 mm

SIDE C

Sector 7

NTB_0004-0008-OpenEnvelope - OPEN
ENVELOPE OF CRYORING, ALL SECTORS

NMA_0005 - BARREL PROJECTIVE ALIGNMENT.
- SIMPLE 3-D MODEL. SECTOR 9

Clash

-19 mm

Not inspected

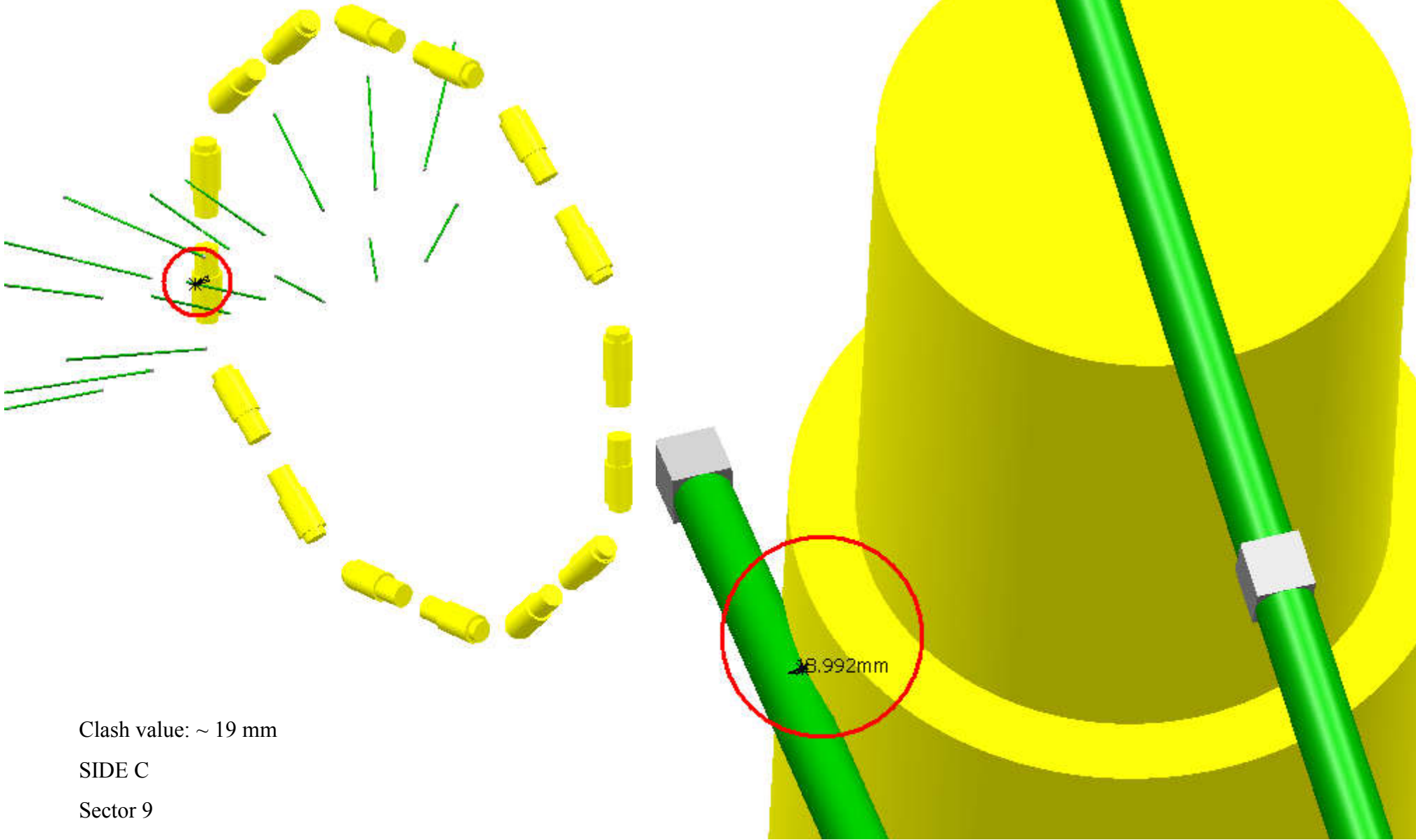

Clash value: ~ 19 mm

SIDE C

Sector 9

NTB_0004-0008-OpenEnvelope - OPEN
ENVELOPE OF CRYORING, ALL SECTORS

NMA_0006 - BARREL PROJECTIVE ALIGNMENT.
- SIMPLE 3-D MODEL. SECTOR 11

Clash

-19 mm

Not inspected

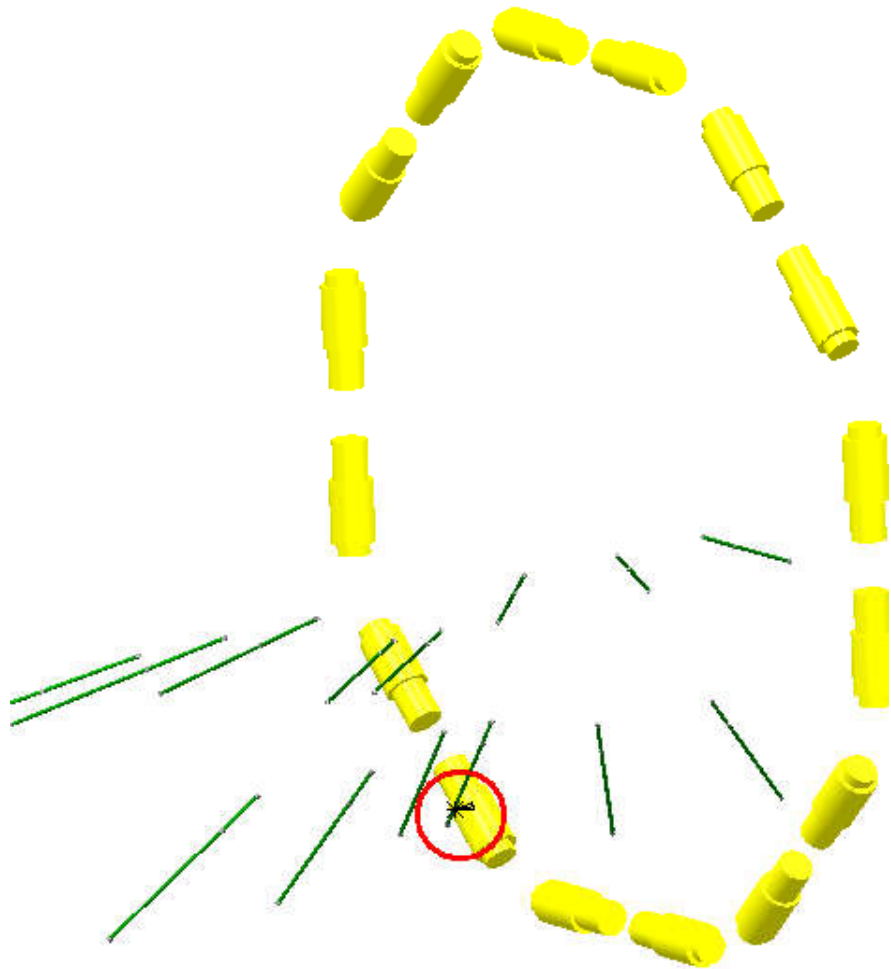

Clash value: ~ 19 mm

SIDE C

Sector 11

NTB_0004-0008-OpenEnvelope - OPEN ENVELOPE OF CRYORING, ALL SECTORS

NMA_0008 - BARREL PROJECTIVE ALIGNMENT. - SIMPLE 3-D MODEL. SECTOR 15

Clash

-19 mm

Not inspected

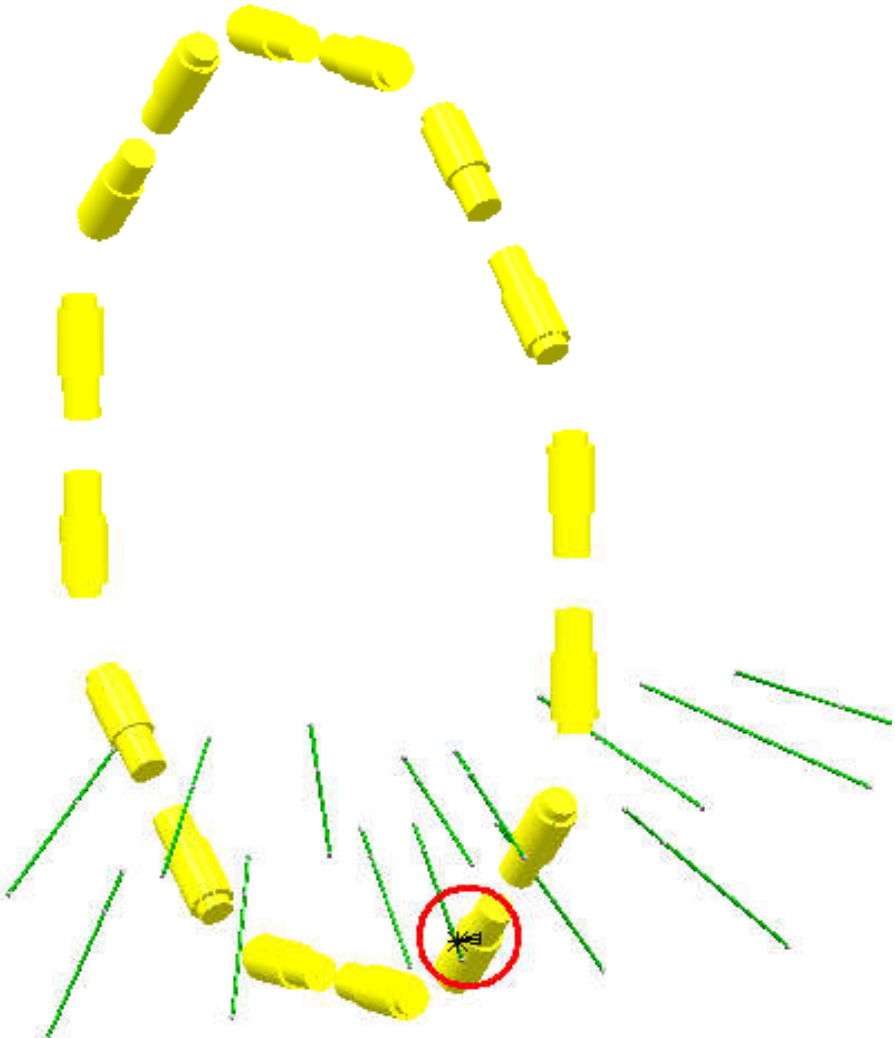

Clash value: ~ 19 mm

SIDE C

Sector 15

Figure.1)

Figure.1)

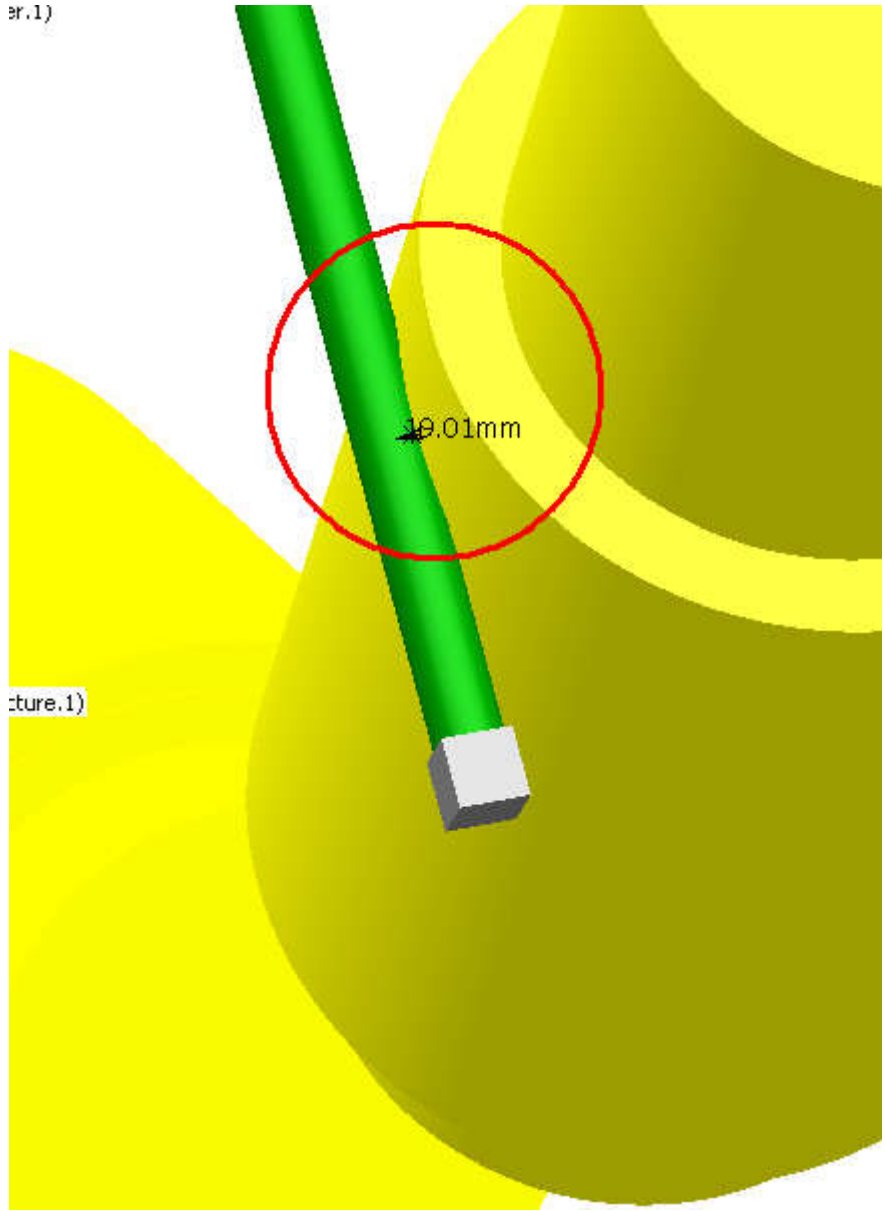

NTB_0004-0008-OpenEnvelope - OPEN
ENVELOPE OF CRYORING, ALL SECTORS

NSR_0007 - TB CABLE SERVICE - CABLE TRAYS

Clash

-128.7 mm

Not inspected

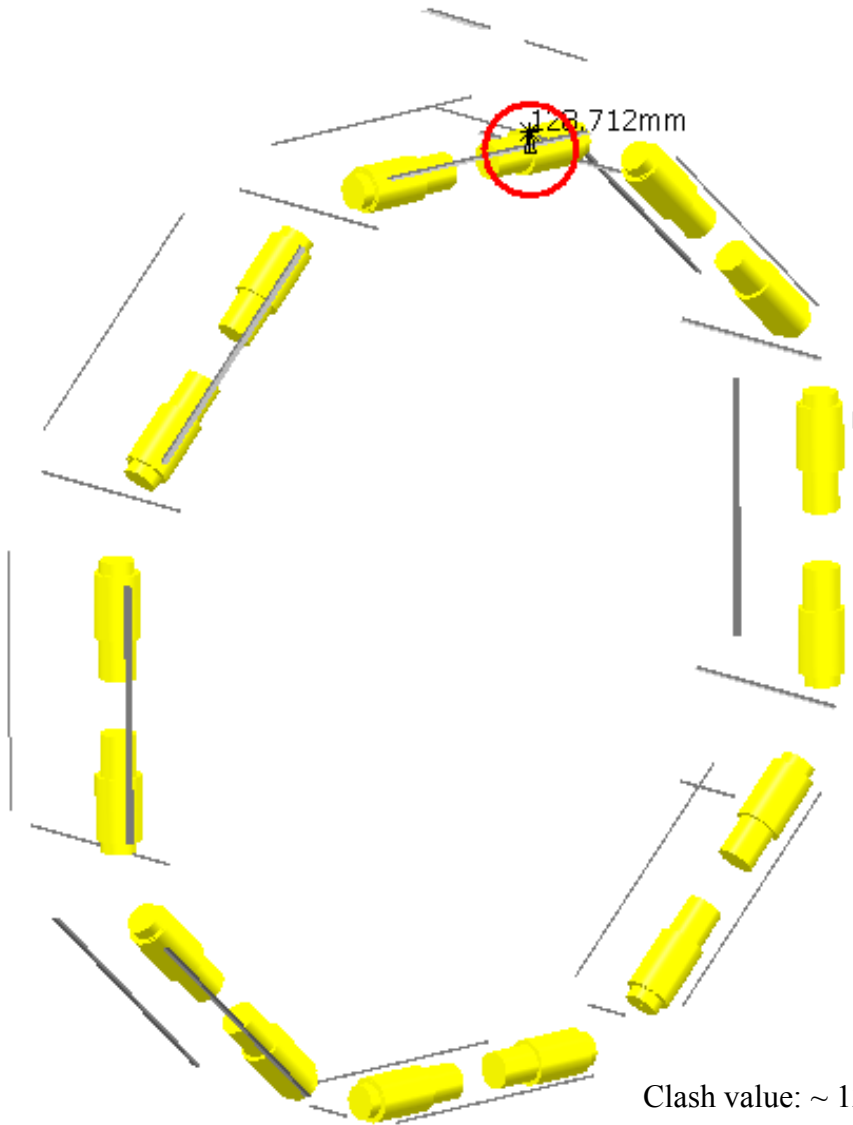

Clash value: ~ 128.7 mm

SIDE C

Sector 5

