

Clash Publish



| Clash Computation Specification | | | |
|---|---|---------|---------------|
| Products Selected | | | |
| ATCNSG_0011 UX 15 - CAVERN US SIDE - PATCH- PANEL AND GAS RACKS | ATCNFV_0007 ATLAS - UX15 CAVERN - 3126 - SUPPLY LOW AIR DUCTS SIDE US15 | -26.34 | Not inspected |
| | ATCNFH_0011 HS METALLIC STRUCTURE - SIDE US15 - LOWER PART | -29.98 | Not inspected |
| | ATCNFH_0012 HS METALLIC STRUCTURE - SIDE US15 - UPPER PART | -44 | Not inspected |
| | ATCNSR_0002 UX 15 RACKS - SIDE US 15 | -600.52 | Not inspected |
| | ATCNSG_0010 UX 15 - CAVERN US SIDE - GAS PIPES DITRIBUTION | -47.9 | Not inspected |
| | ATCNZO_0008 UX 15 - CAVERN - EVAPORATIF SYSTEM | -600.52 | Not inspected |

Computation Result:

ATCNSG_0011 UX 15 - CAVERN US SIDE - PATCH-PANEL AND GAS RACKS

ATCNFV_0007 ATLAS - UX15 CAVERN - 3126 - SUPPLY LOW AIR DUCTS SIDE US15

Clash

-26.34mm

Not inspected

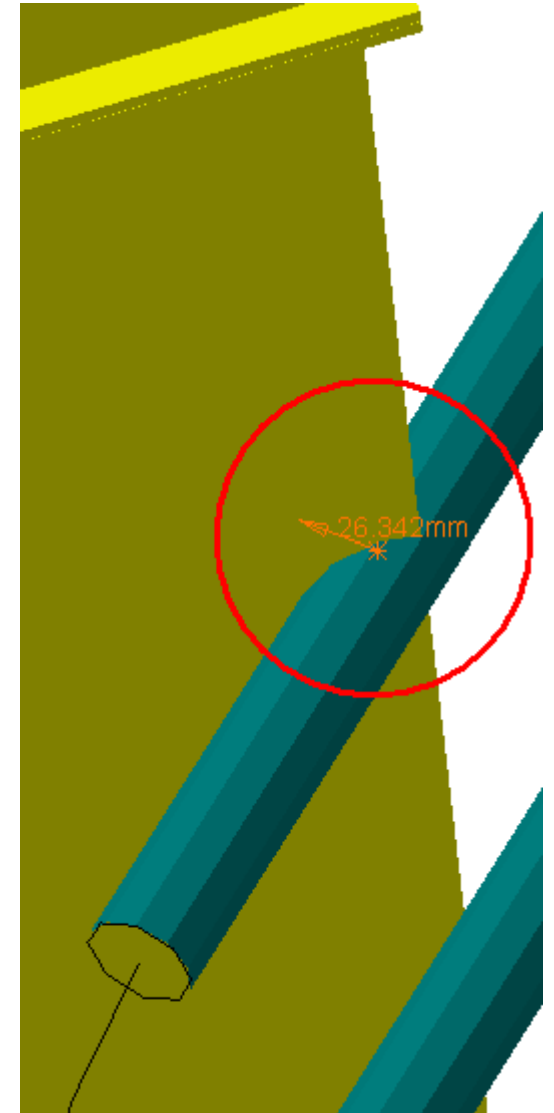
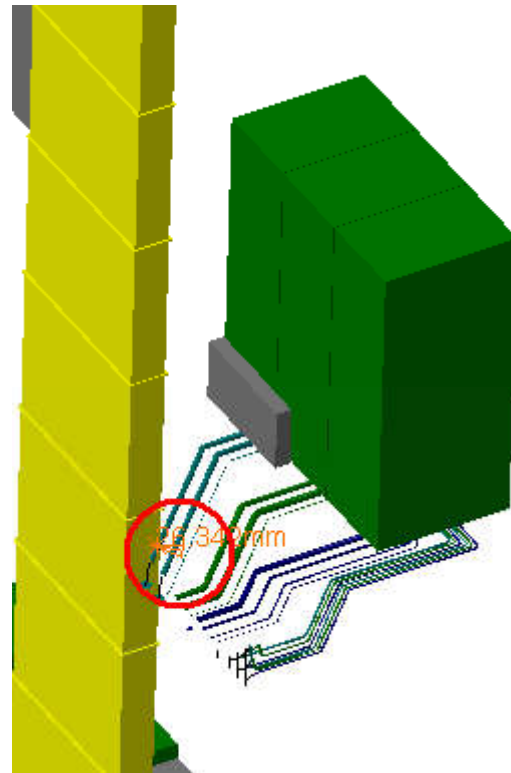
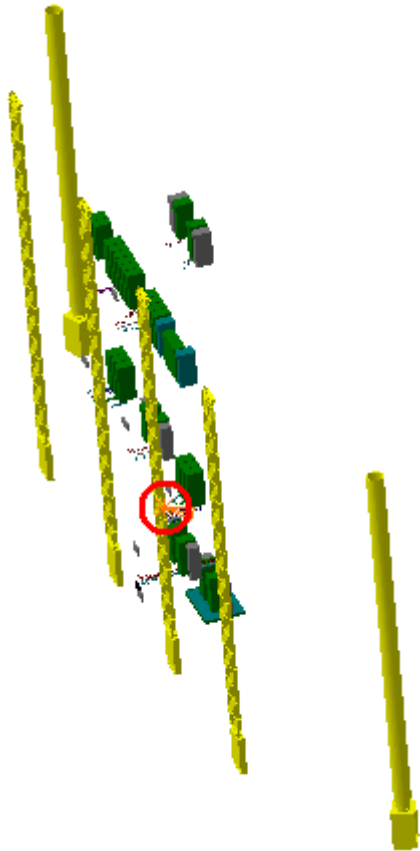

ATCNSG_0011 UX 15 - CAVERN US SIDE - PATCH-PANEL AND GAS RACKS

ATCNFH_0011 HS METALLIC STRUCTURE - SIDE US15 - LOWER PART

Clash

-29.98mm

Not inspected

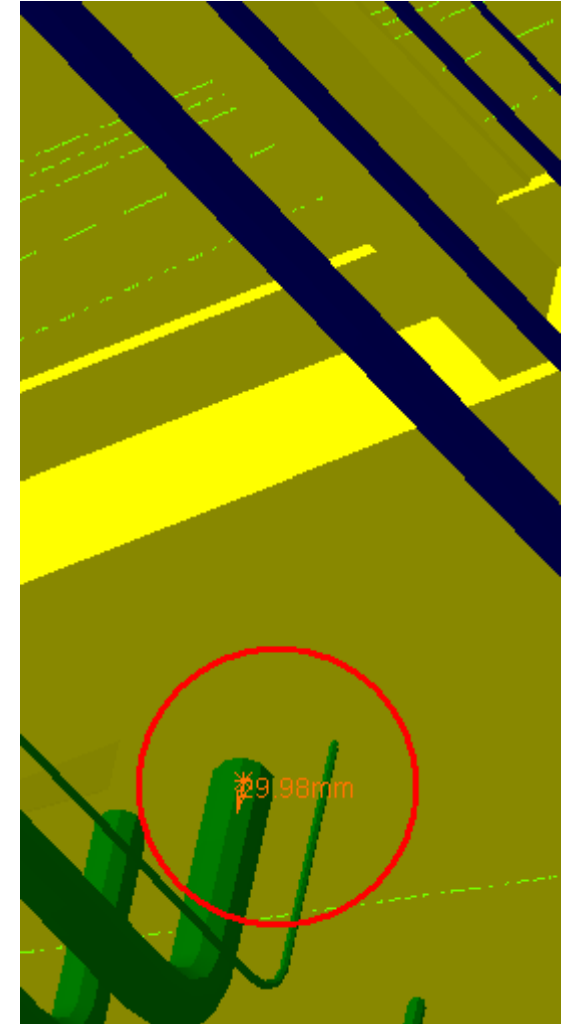
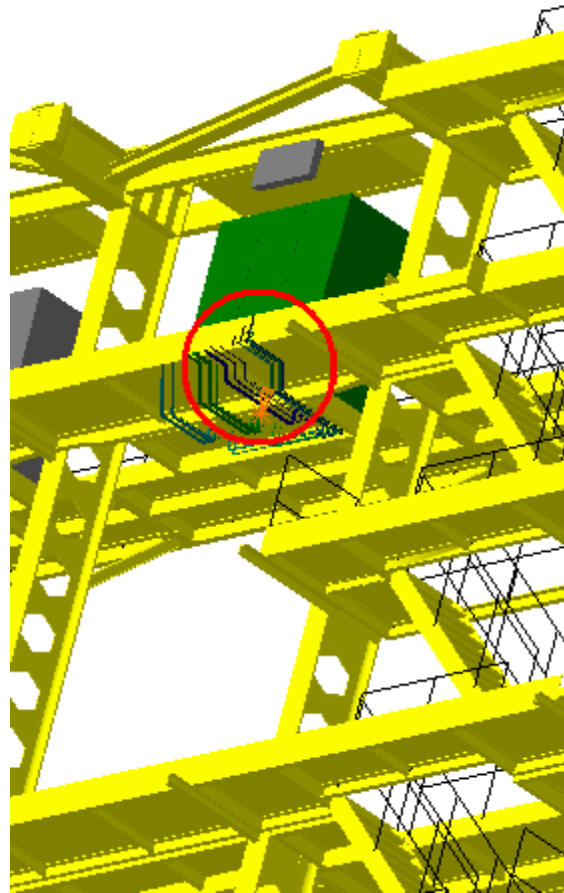
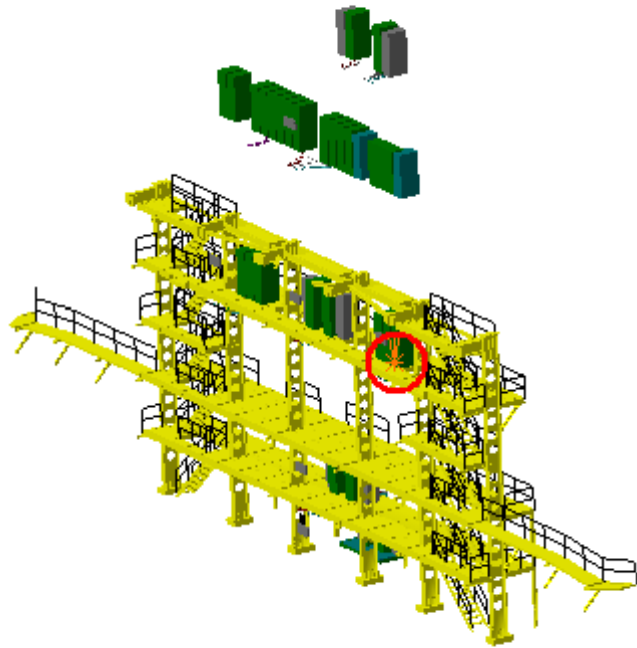

Clash View 1:

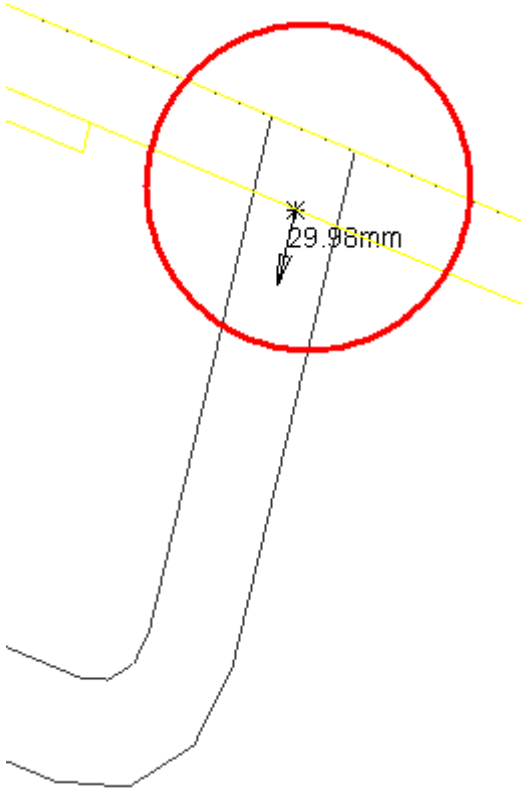
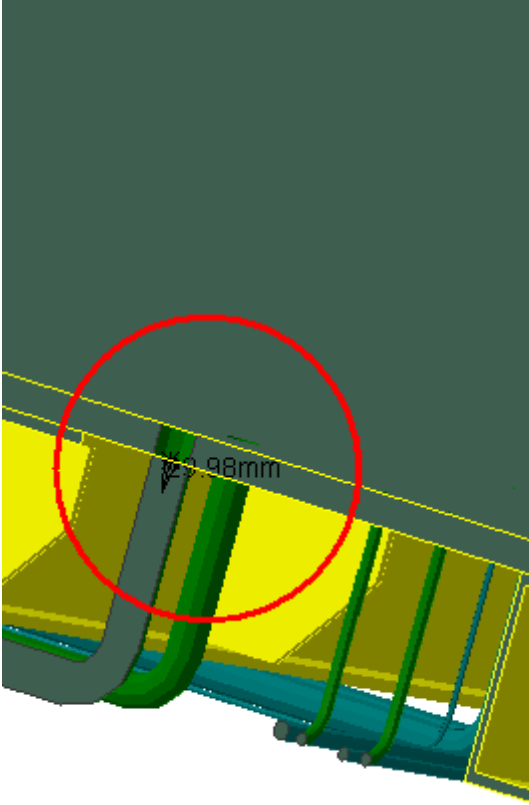
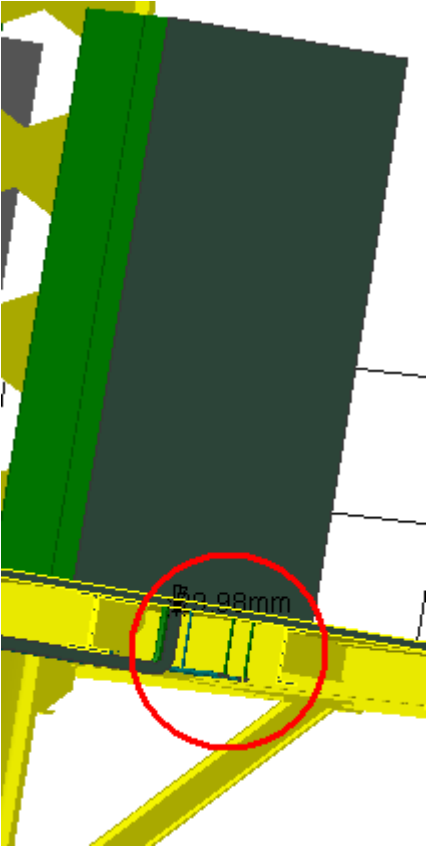

ATCNSG_0011 UX 15 - CAVERN US SIDE - PATCH-PANEL AND GAS RACKS

ATCNFH_0012 HS METALLIC STRUCTURE - SIDE US15 - UPPER PART

Clash

-44mm

Not inspected

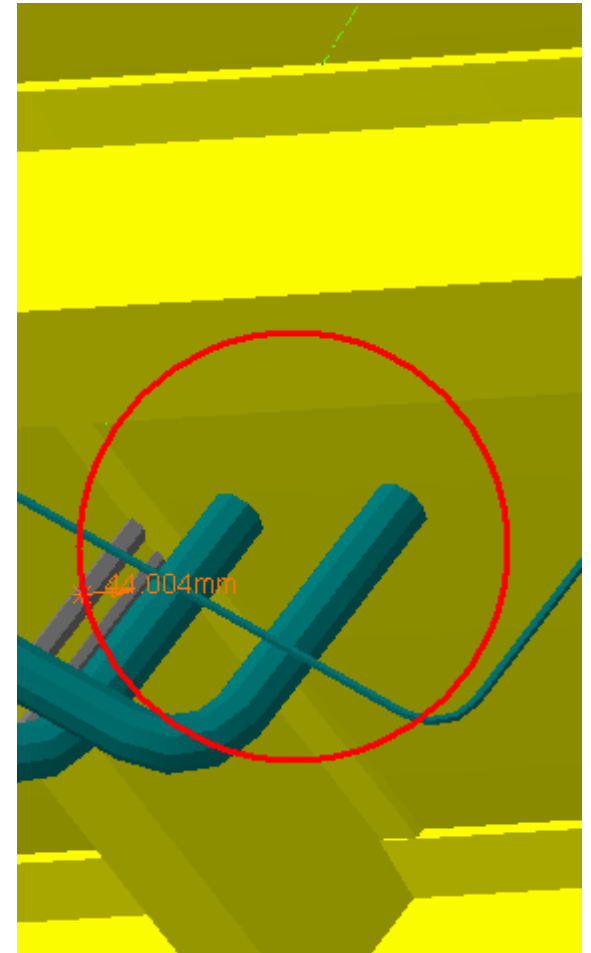
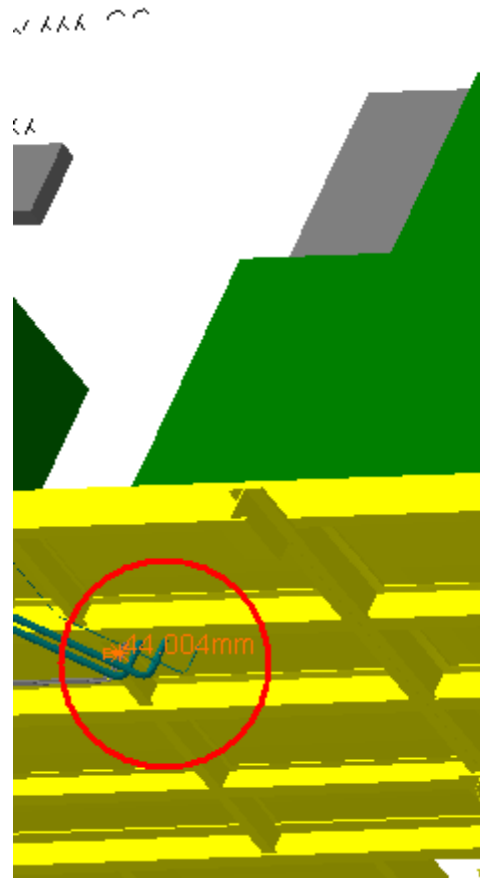
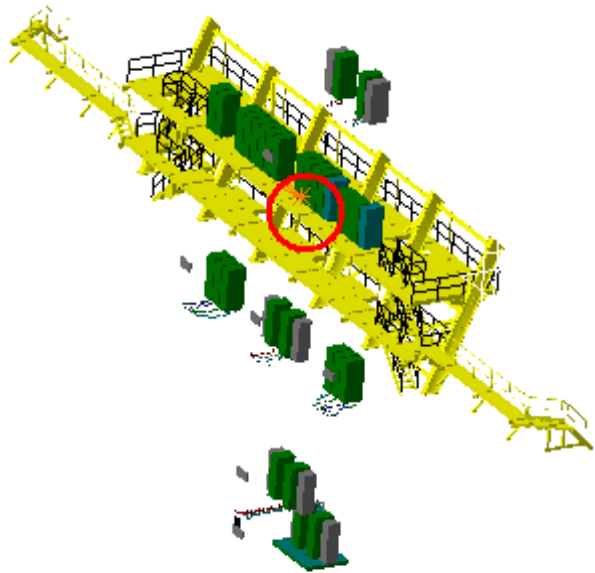

Clash View 1:

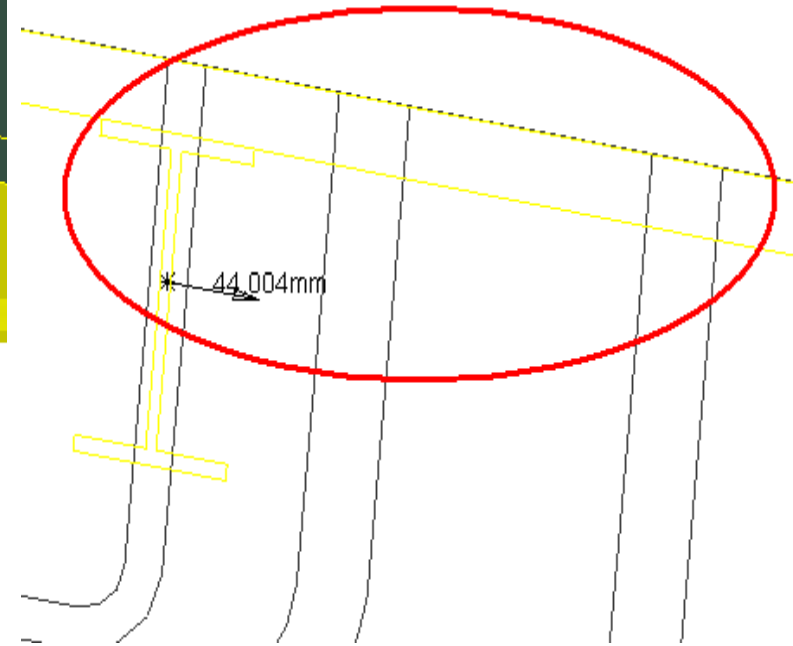
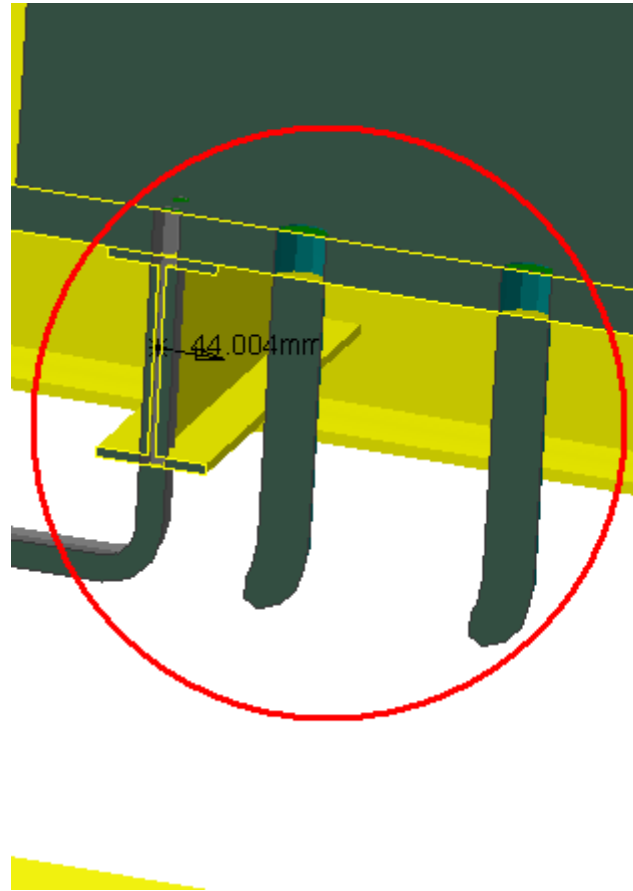
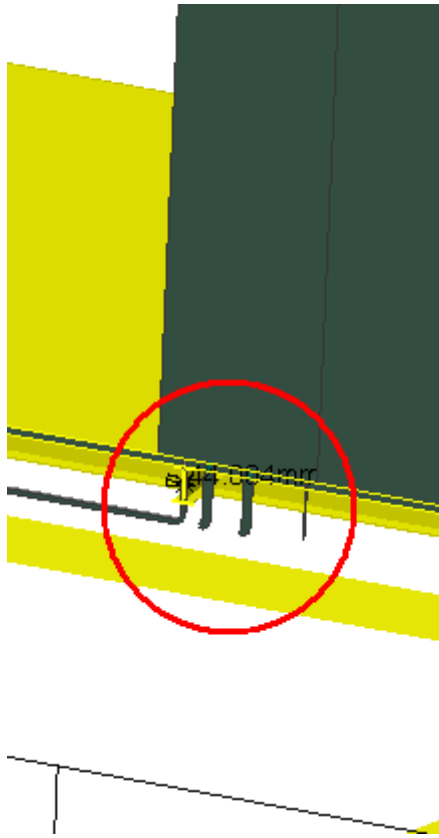

ATCNSG_0011 UX 15 - CAVERN US SIDE - PATCH-PANEL AND GAS RACKS

ATCNSR_0002 UX 15 RACKS - SIDE US 15

Clash

-600.52mm

Not inspected

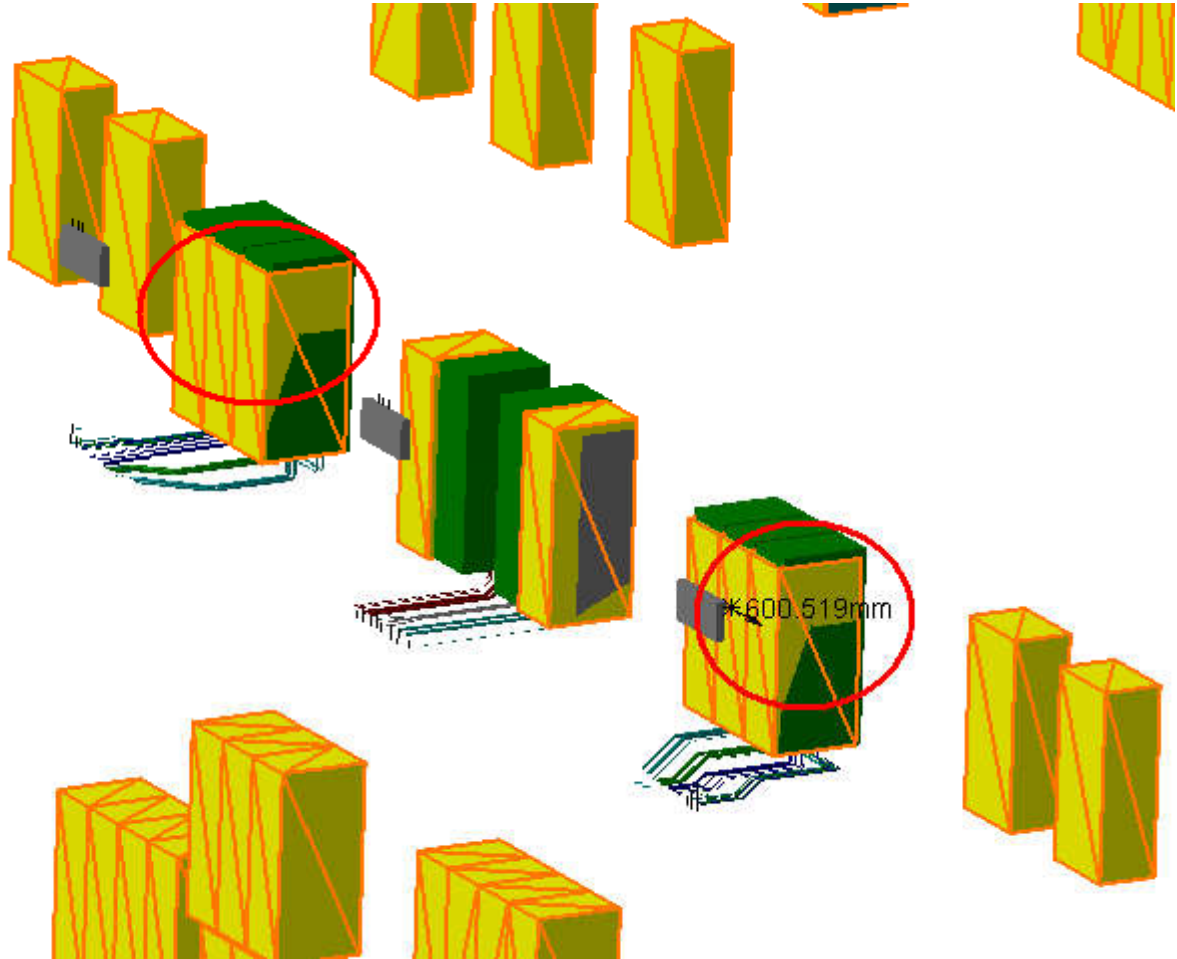
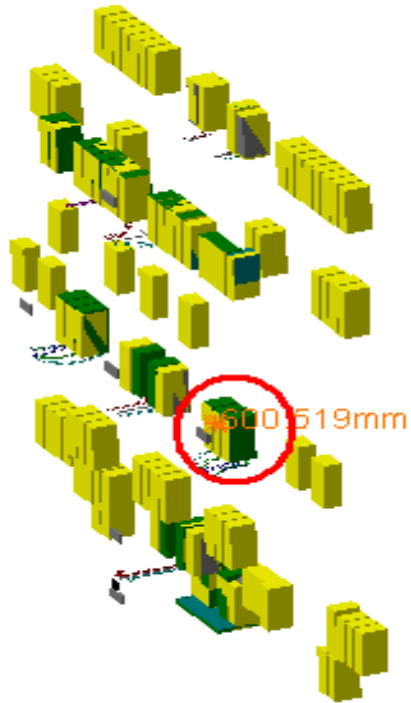

ATCNSG_0011 UX 15 - CAVERN US SIDE - PATCH-PANEL AND GAS RACKS

ATCNSG_0010 UX 15 - CAVERN US SIDE - GAS PIPES DITRIBUTION

Clash

-47.9mm

Not inspected

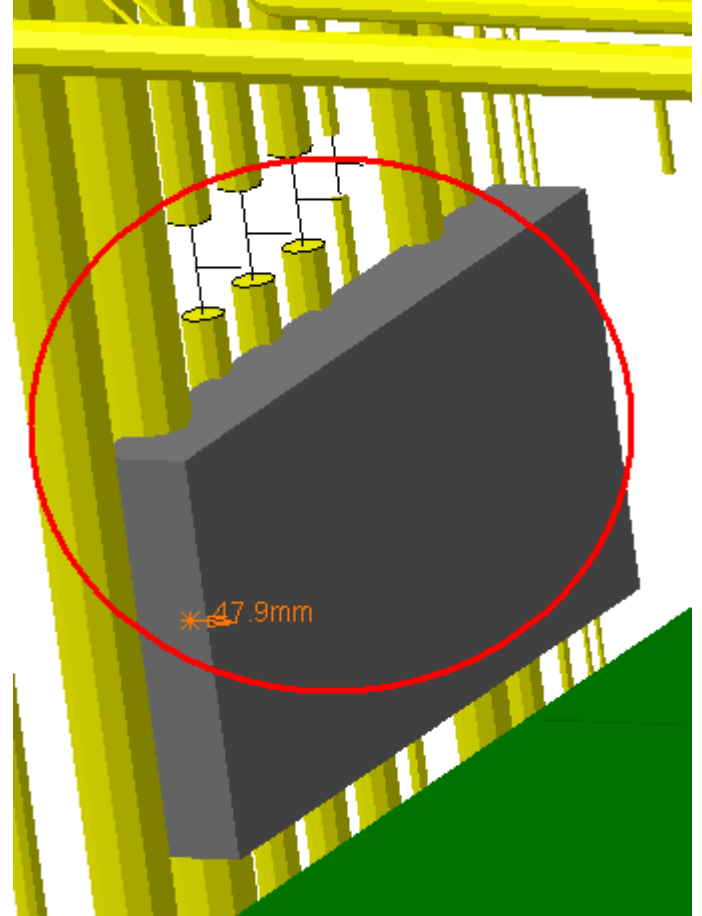
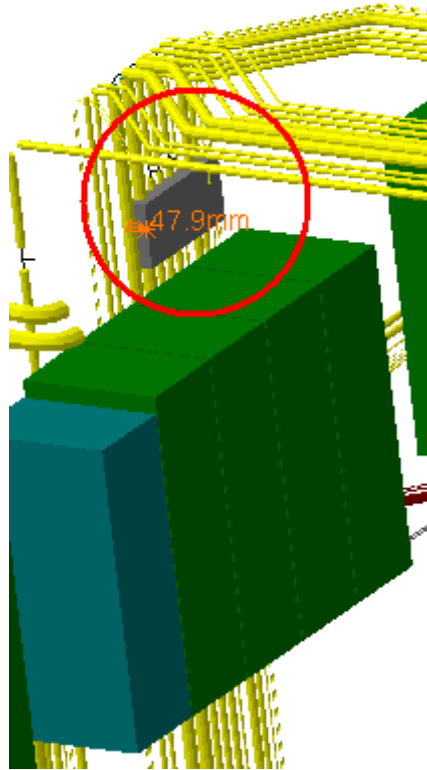
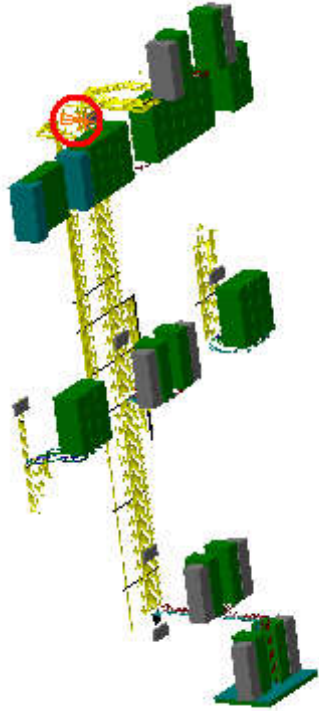

ATCNSG_0011 UX 15 - CAVERN US SIDE - PATCH-PANEL AND GAS RACKS

ATCNSO_0008 UX 15 - CAVERN - EVAPORATIF SYSTEM

Clash

-600.52mm

Not inspected

