



## Clash Publish

Clash Computation Specification			
Products Selected		Value	Status
AT602157MQ - MUON BARREL CHAMBERS DETAILED, SECTOR 7	NMA_0004 - BARREL PROJECTIVE ALIGNMENT. - SIMPLE 3-D MODEL. SECTOR 7	-6.3	Not inspected
	NMA_0013 - SECTOR 06 SIDE C (A) - REFERENCE ALIGNMENT SYSTEM AND	-73.8	Not inspected
	NMA_0014 - SECTOR 08 SIDE C (A) - REFERENCE ALIGNMENT SYSTEM AND	-87.8	Not inspected
	NSE_0001 - FLEXIBLE SAFETY PIPE FOR - LAR END-CAP CALORIMETER *	-25.4	Not inspected

### Computation Result:

\*Working on new version

AT602157MQ - MUON BARREL  
CHAMBERS DETAILED, SECTOR 7

NMA\_0004 - BARREL PROJECTIVE ALIGNMENT. -  
SIMPLE 3-D MODEL. SECTOR 7

Clash

-6.2539

Not inspected

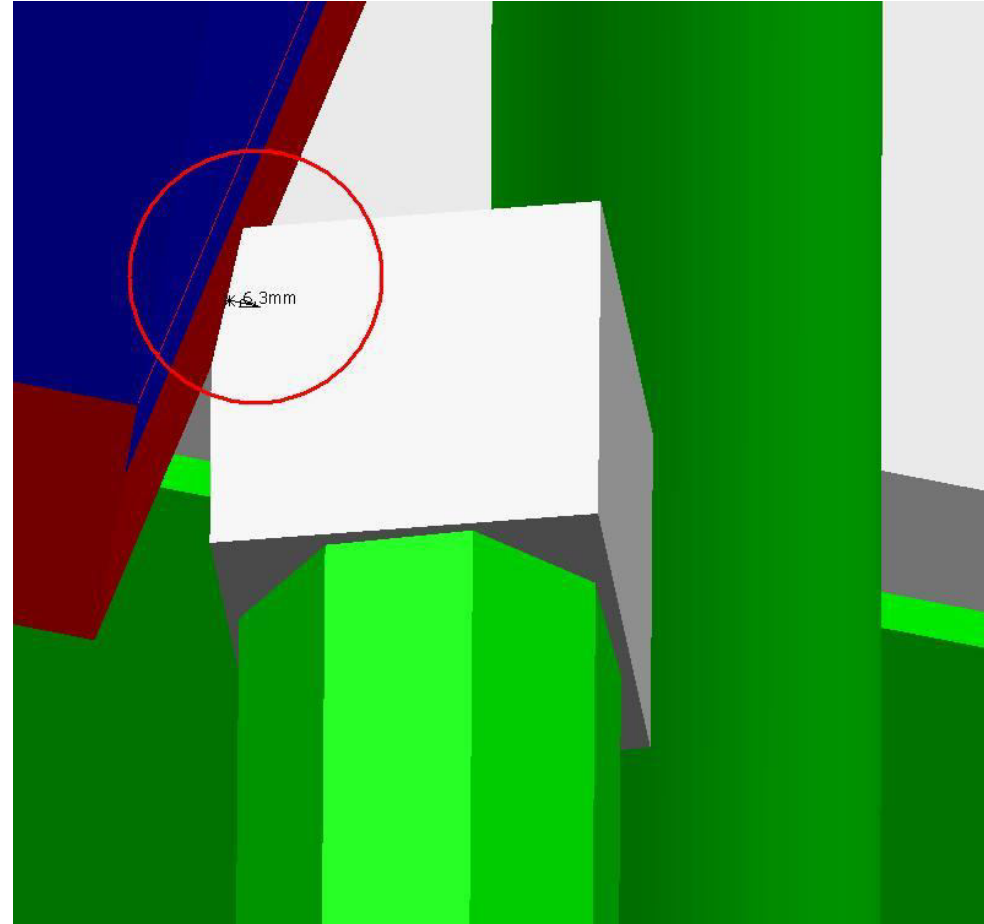
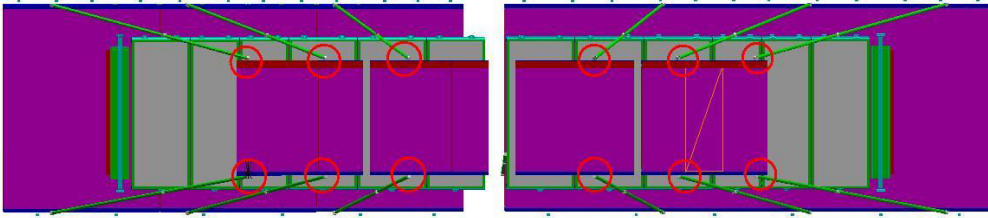

Clash value: ~ 6.3 mm

SIDE A-C

Sector 7

# Clash View:

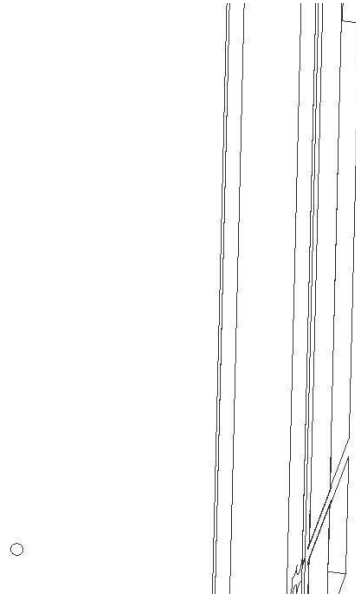
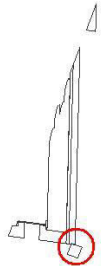
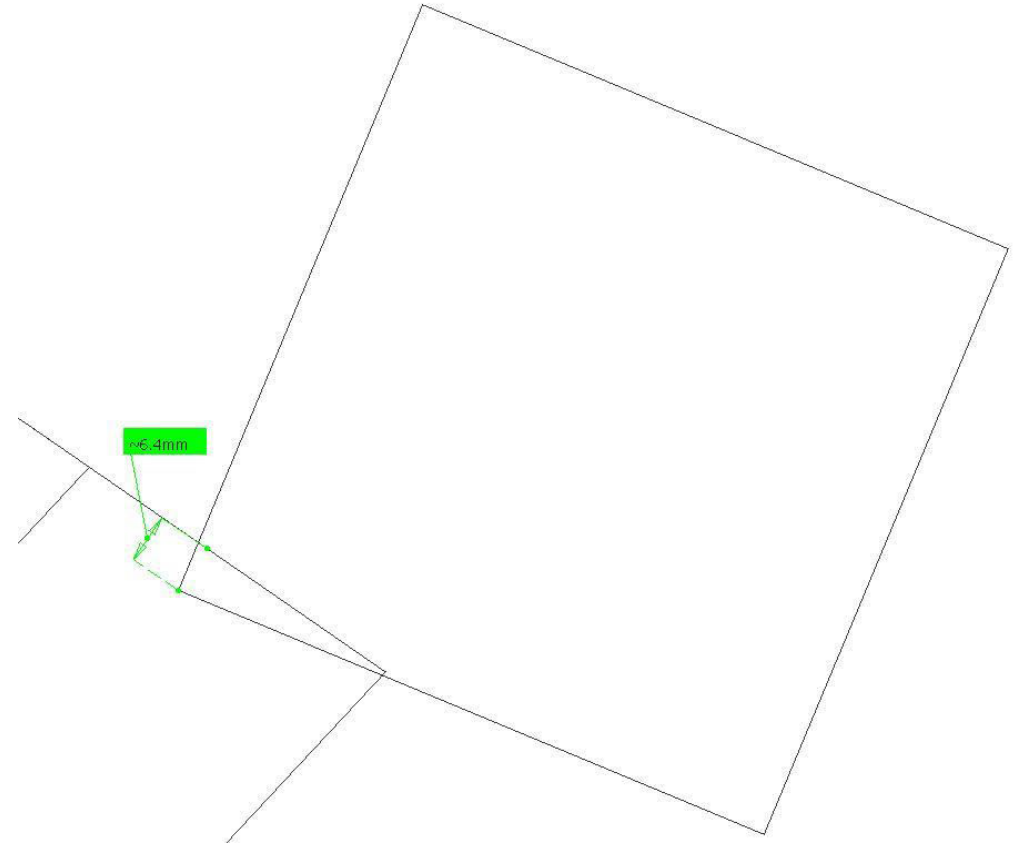
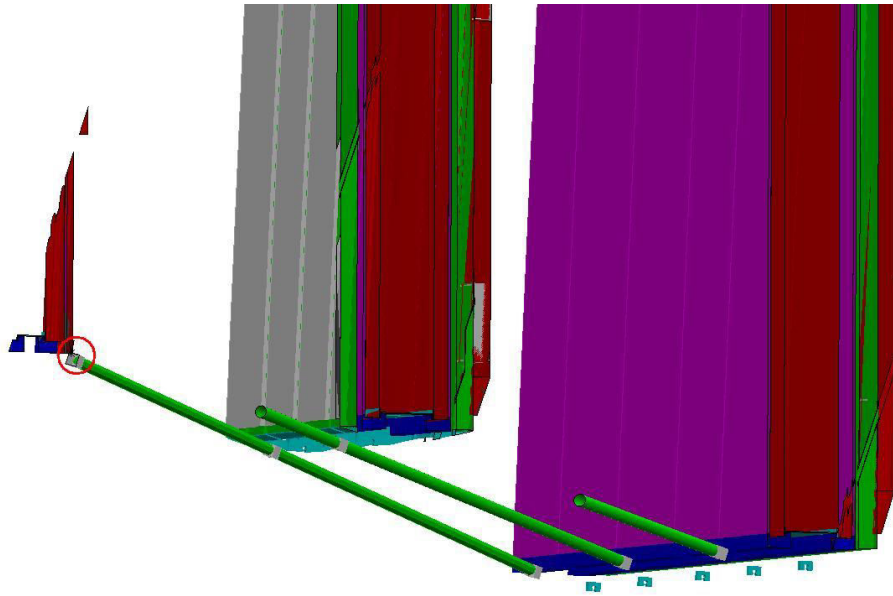

AT602157MQ - MUON BARREL  
CHAMBERS DETAILED, SECTOR 7

NMA\_0013 - SECTOR 06 SIDE C (A) - REFERENCE  
ALIGNMENT SYSTEM AND

Clash

-73.8139

Not inspected

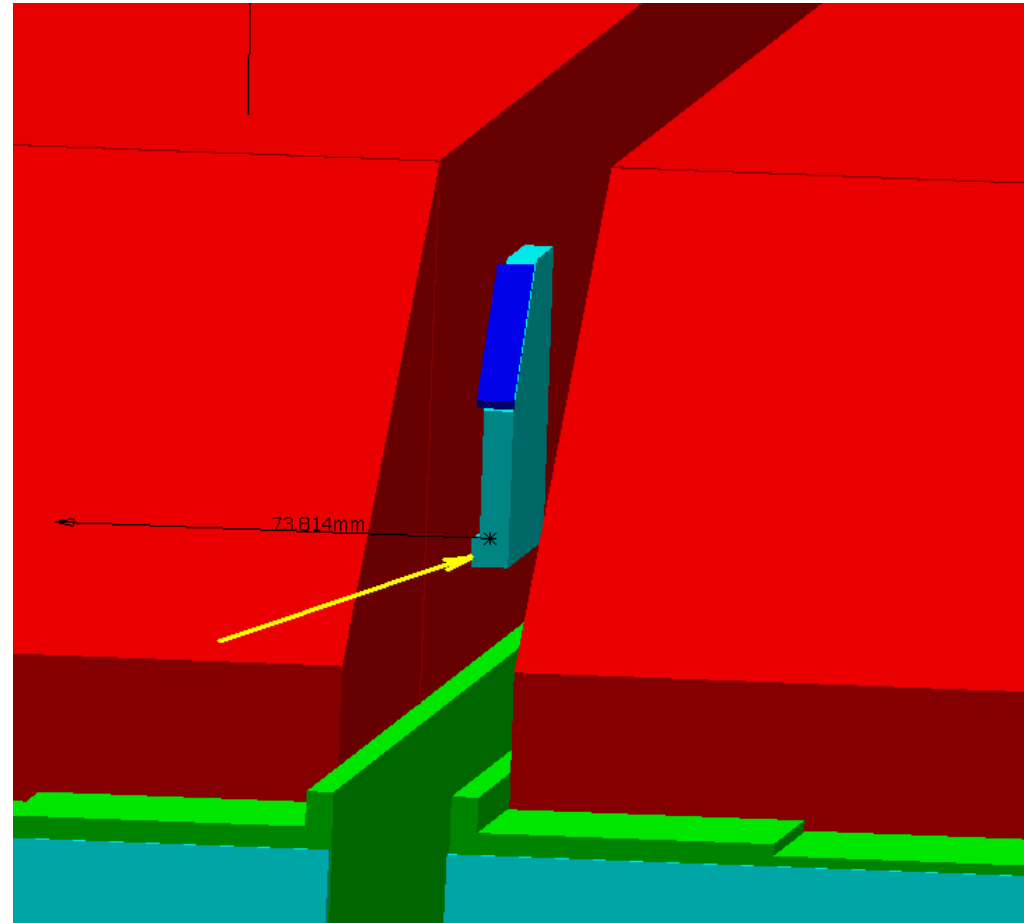
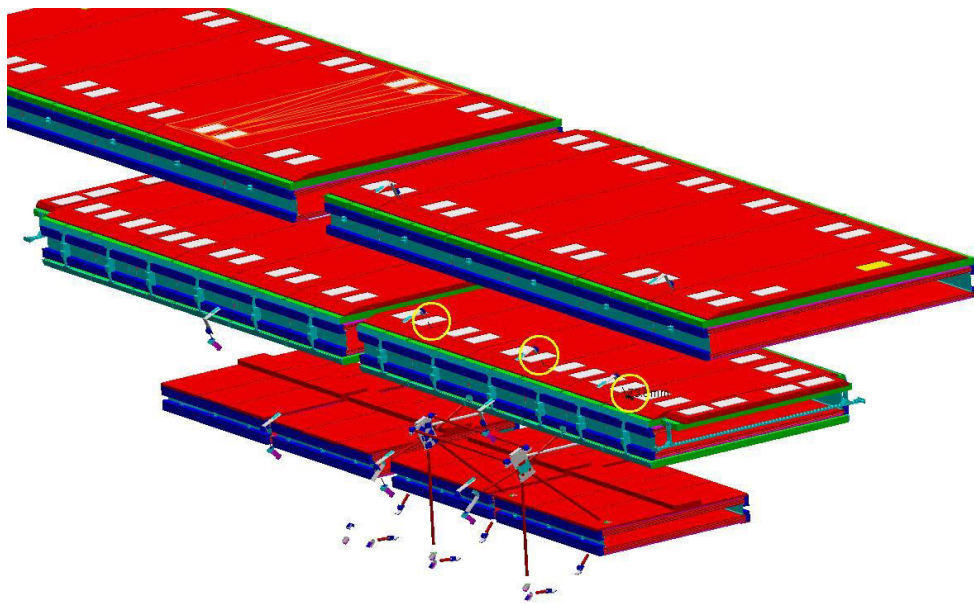

Clash value: ~ 73.8 mm

SIDE C

Sector 7

# Clash View:

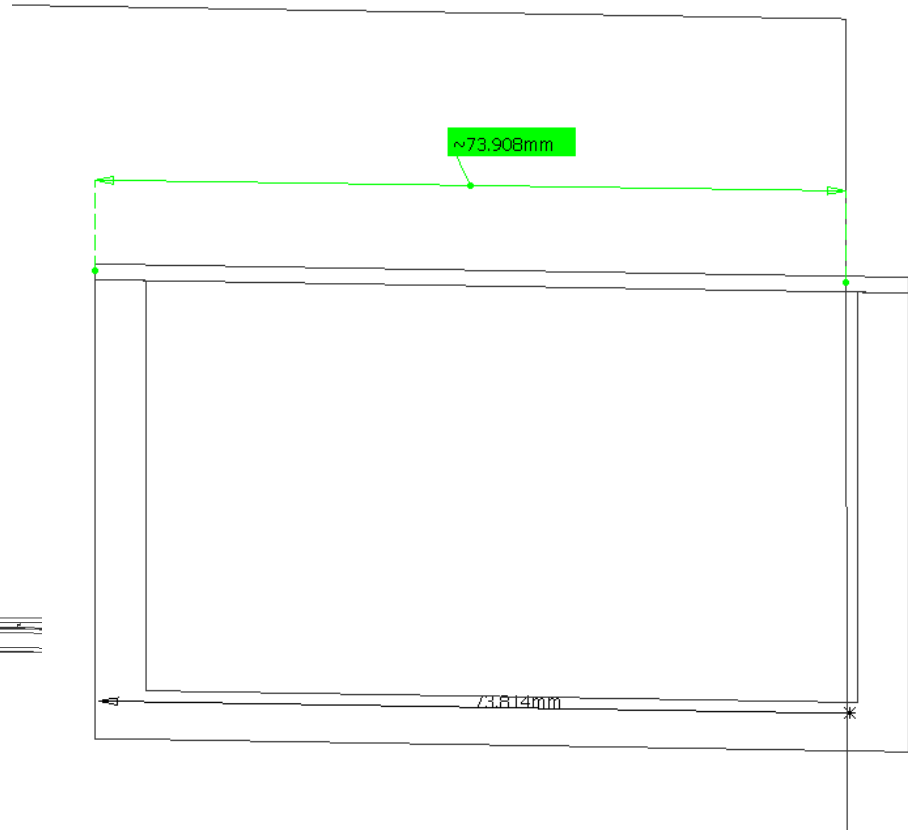
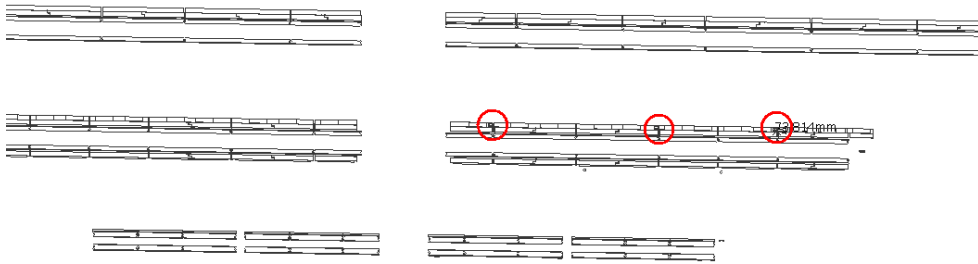
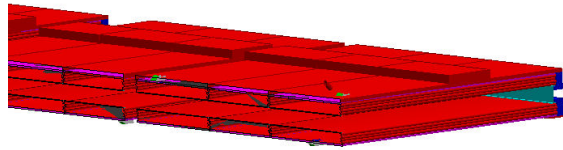
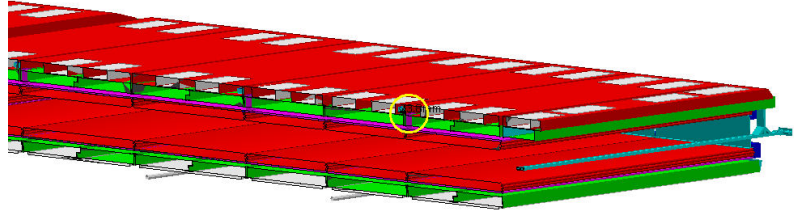
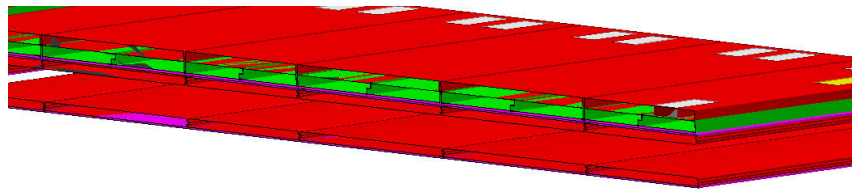

AT602157MQ - MUON BARREL  
CHAMBERS DETAILED, SECTOR 7

NMA\_0014 - SECTOR 08 SIDE C (A) - REFERENCE  
ALIGNMENT SYSTEM AND

Clash

-87.8076

Not inspected

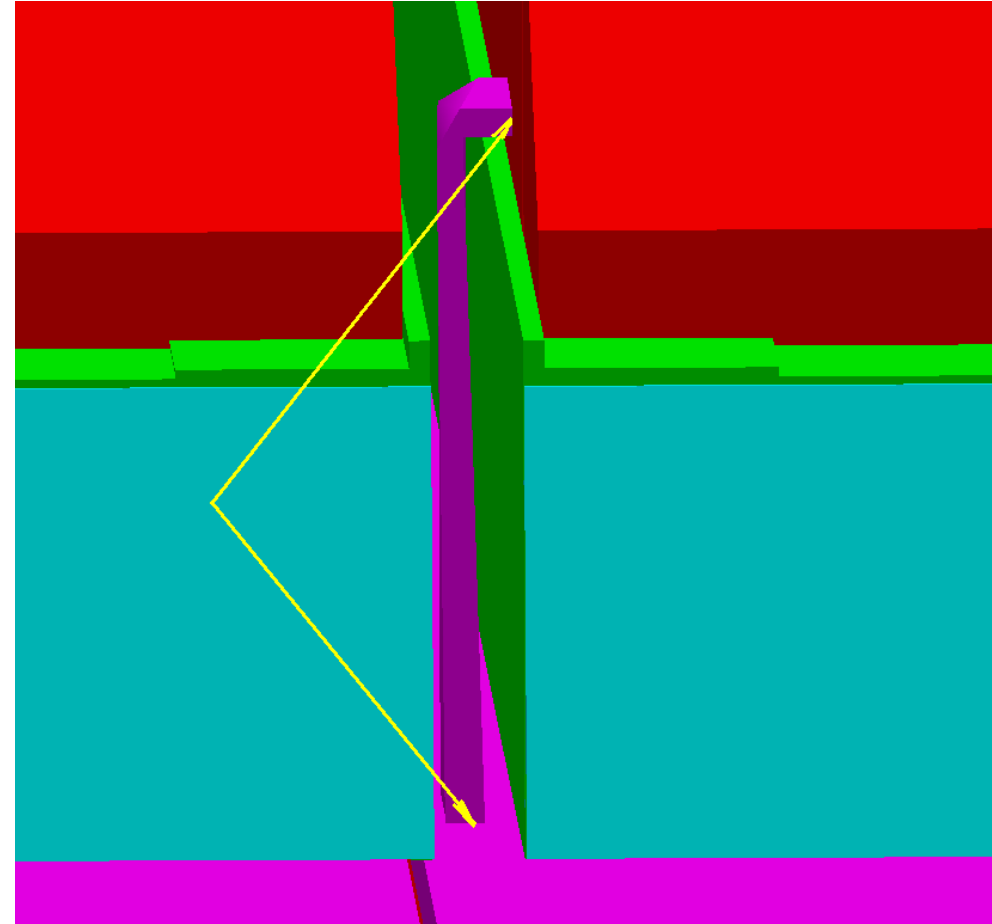
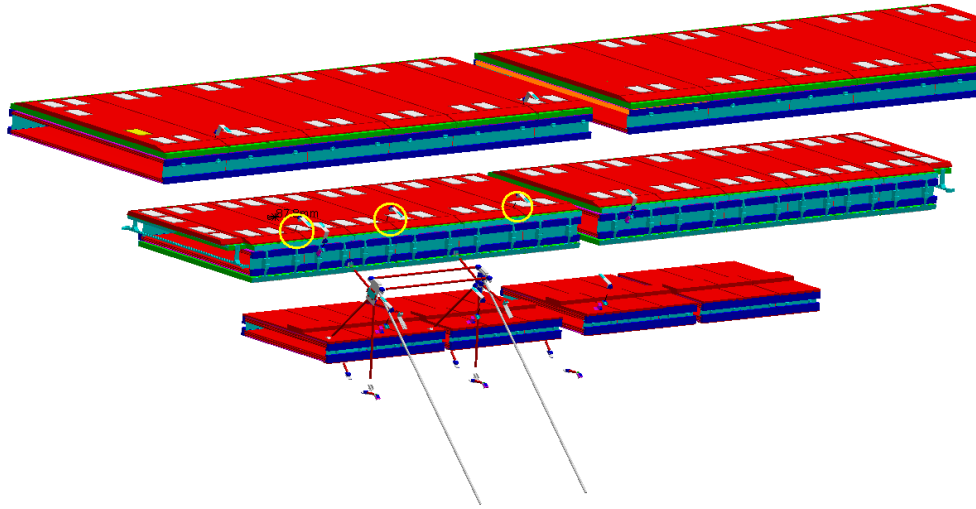

Clash value: ~ 87.8 mm

SIDE C

Sector 7

# Clash View:

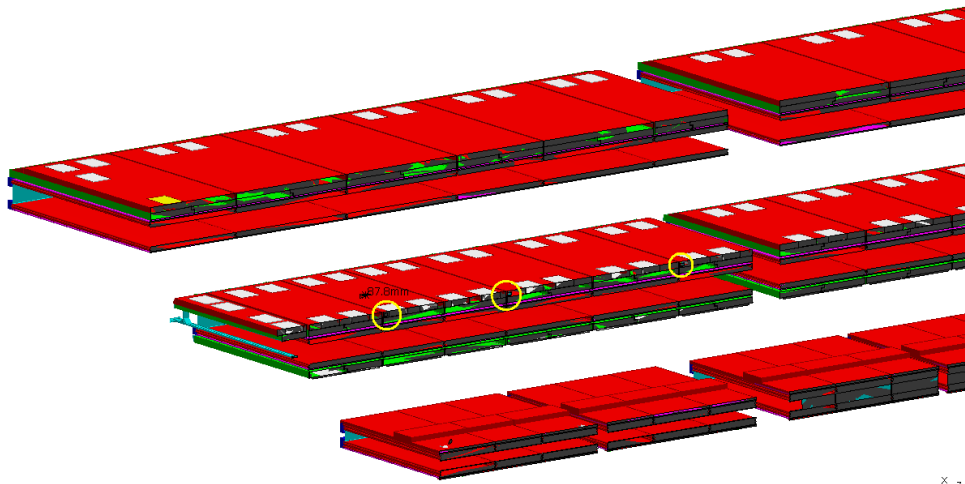

87

