

Clearance Publish

Clearance = 50mm



Clearance Computation Specification

Products Selected		Value	Status
AT602154MQ - MUON BARREL CHAMBERS DETAILED, SECTOR 2	NJ_0003 - JD SHIELDING (SIDE C) - WITH TGC MUON CHAMBERS	44.3	Relevant
	AT602152MQ - MUON BARREL CHAMBERS DETAILED. SECTOR 1	40.7	Not Relevant
	AT602155MQ - MUON BARREL CHAMBERS DETAILED. SECTOR 3	40.9	Not Relevant
	NMC_0018 - SMALL WHEEL (SIDE C) - SIMPLIFIED 3-D OBJECT	36.2	Relevant
	NSM_0014 - BT HEATER BOXES AND CABLES - FOR SEC 2,4,6,8,10	30.3	Not Relevant
	NTB_0001 BT2 - TB STANDARD COIL - SECTORS 2,4,6,8,10,16	23.3	Not Relevant
	NTB_0008 - TB CRYORING TOP SECTORS - (1, 3, 5, 7, 9)	48.7	Relevant

Revised with Olga 1/06/2005

Revised with Tatiana 9/06/2005

AT602154MQ - MUON BARREL CHAMBERS DETAILED, SECTOR 2

NJ_0003 - JD SHIELDING (SIDE C) - WITH TGC MUON CHAMBERS

Clearance

44.2872

Relevant

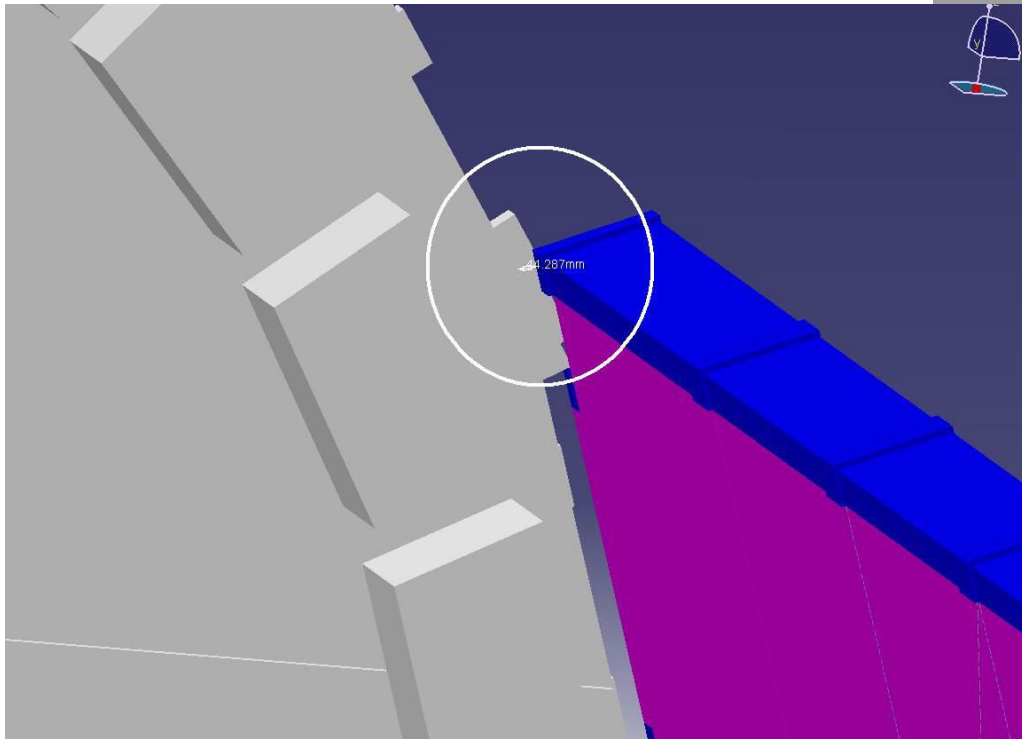
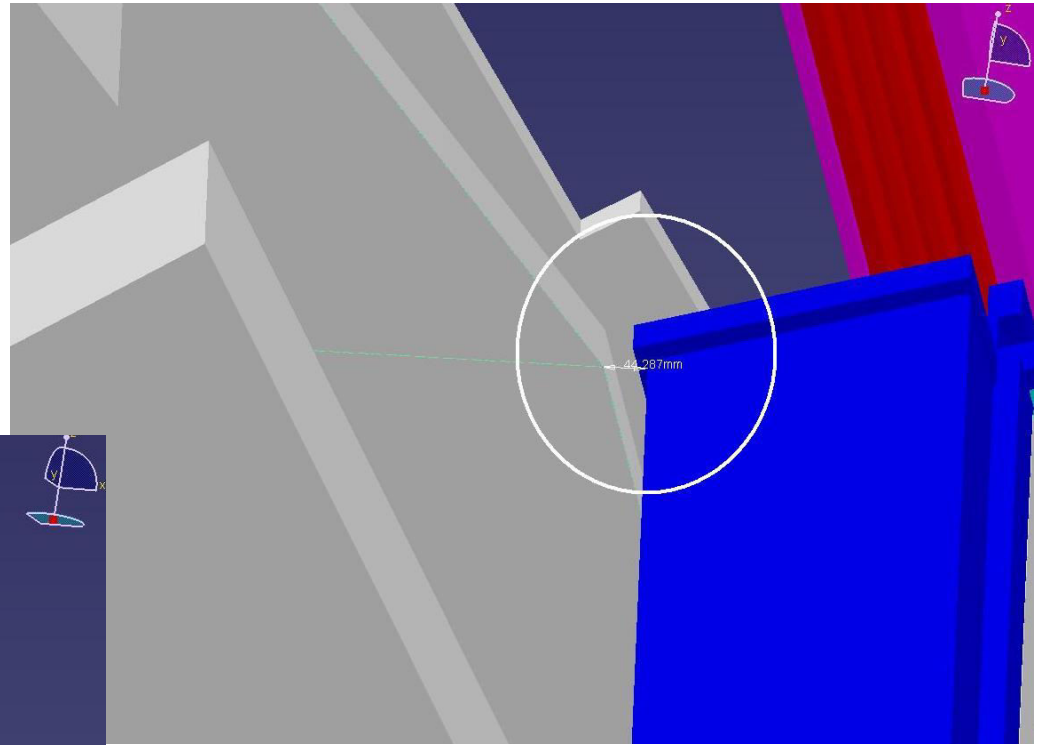
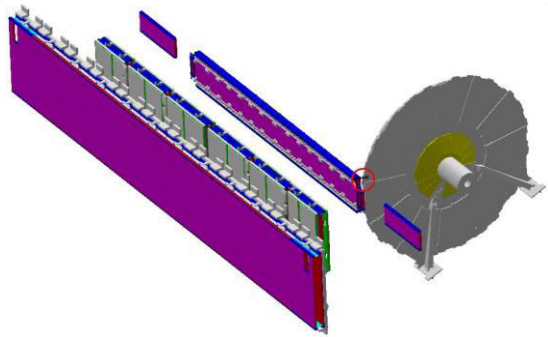

SIDE C, Sector 2
 $\Delta x = -35\text{mm}$
 $\Delta y = 23\text{mm}$
 $\Delta z = -14\text{mm}$

AT602154MQ - MUON BARREL CHAMBERS DETAILED, SECTOR 2	AT602152MQ - MUON BARREL CHAMBERS DETAILED. SECTOR 1	Clearance	40.7135	Not Relevant
---	---	-----------	---------	--------------

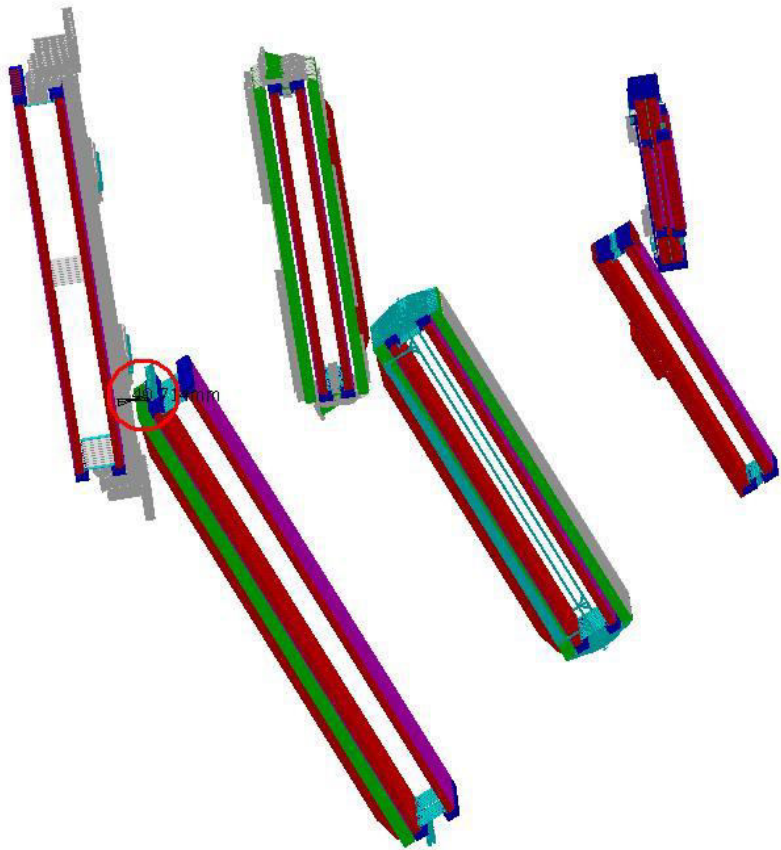

SIDE A-C
Sector 2

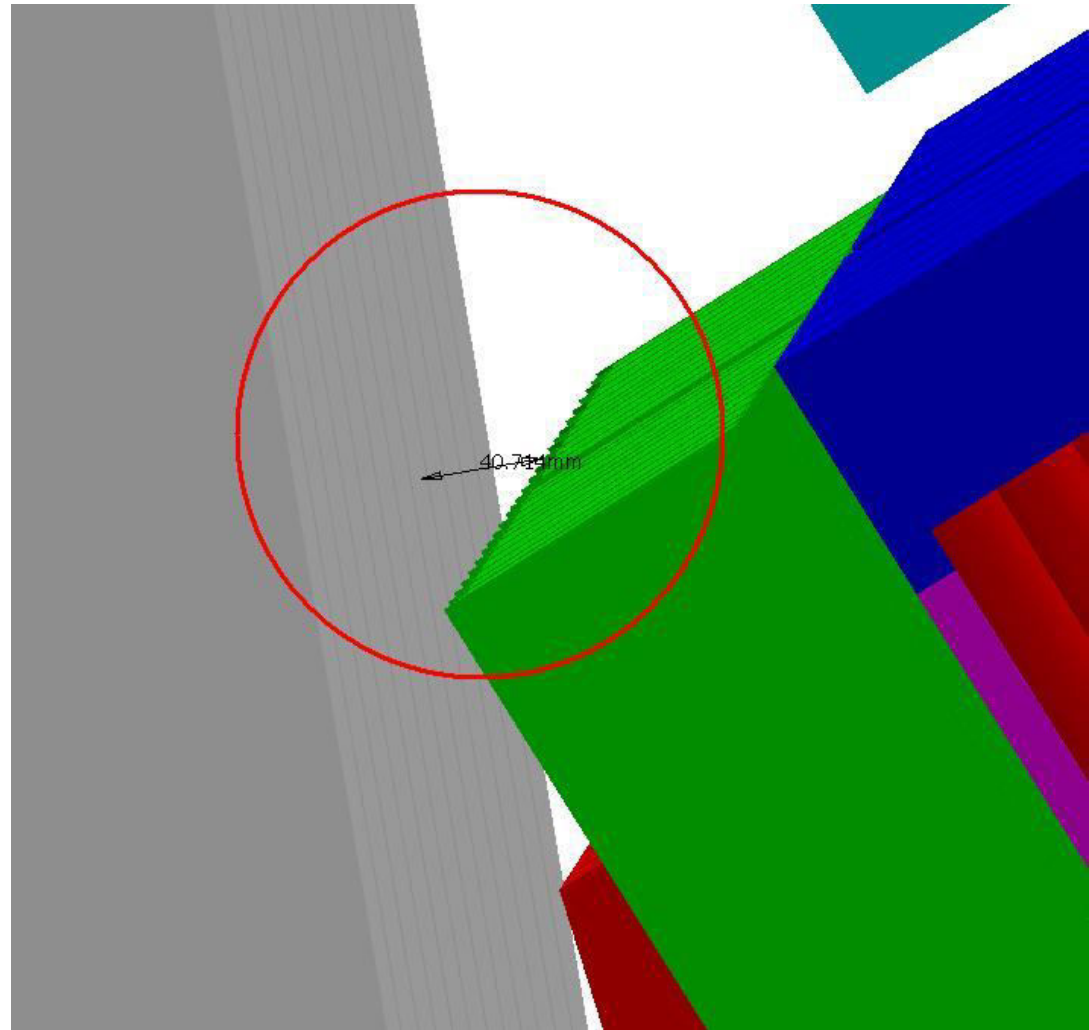

AT602154MQ - MUON BARREL CHAMBERS DETAILED, SECTOR 2	AT602155MQ - MUON BARREL CHAMBERS DETAILED. SECTOR 3	Clearance	40.6976	Not Relevant
---	---	-----------	---------	--------------

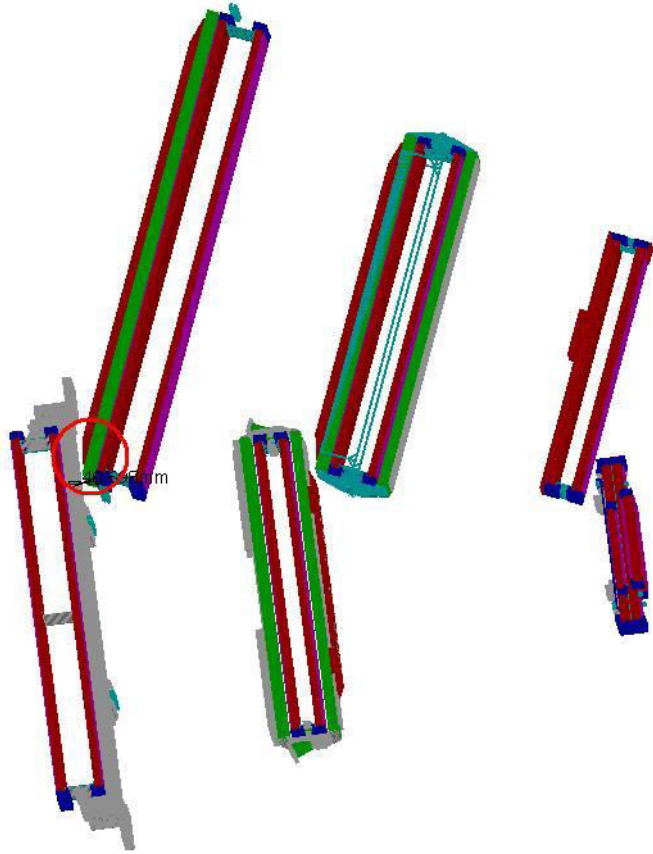

SIDE A-C
Sector 2

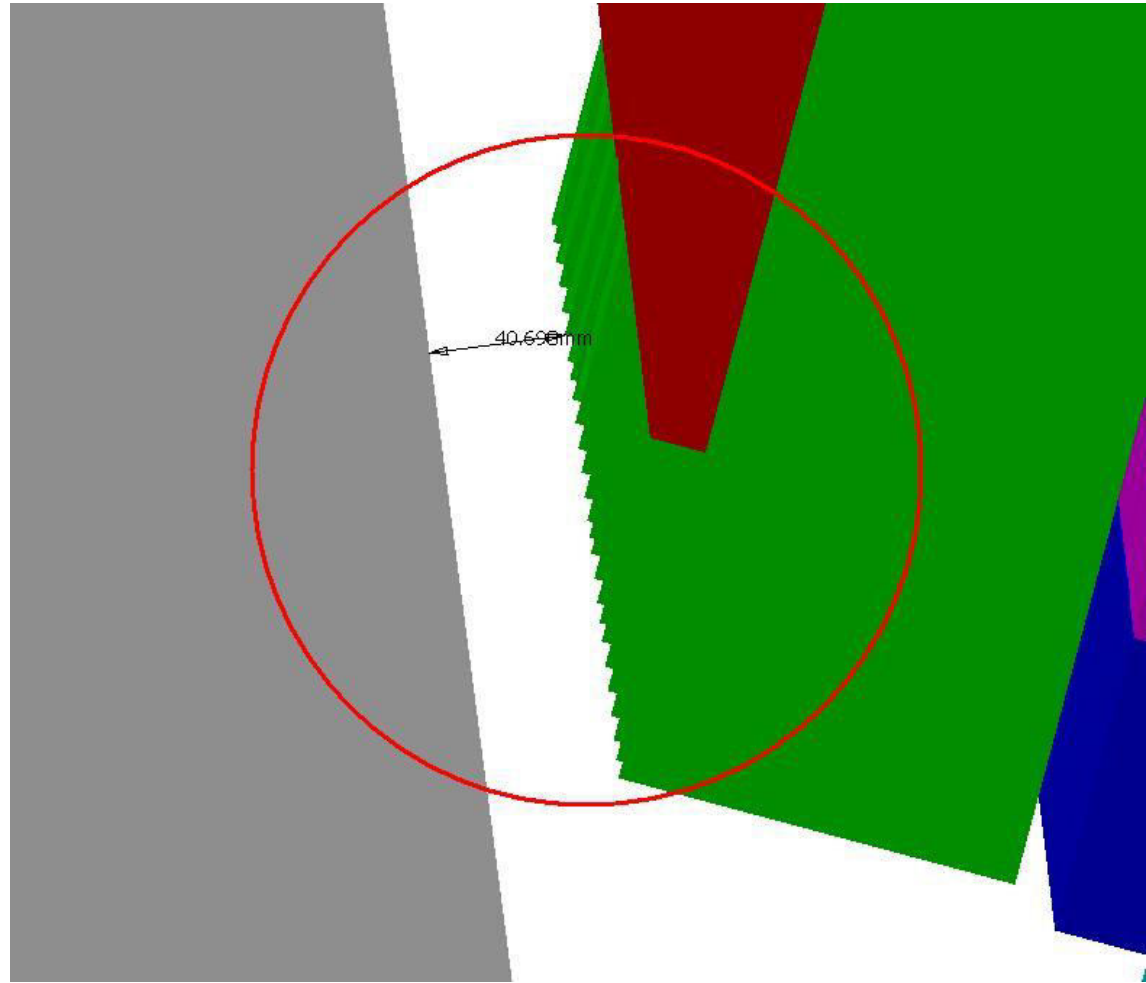

AT602154MQ - MUON BARREL CHAMBERS DETAILED, SECTOR 2	NMC_0018 - SMALL WHEEL (SIDE C) - SIMPLIFIED 3-D OBJECT	Clearance	36.2368	Relevant
---	--	-----------	---------	----------

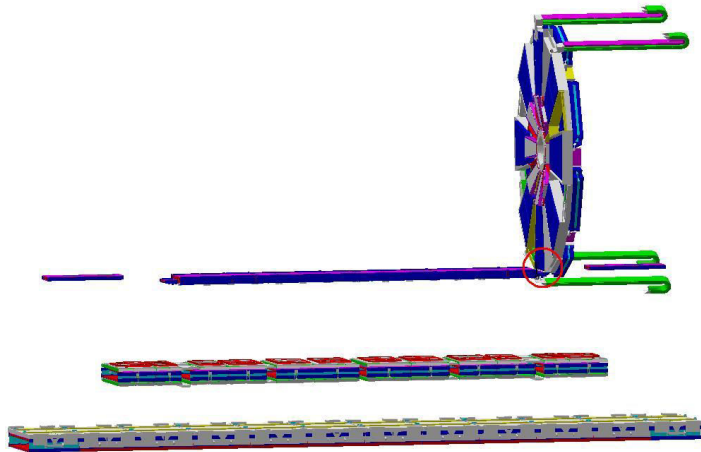

SIDE C, Sector 2
 $\Delta x = -33.5\text{mm}$
 $\Delta y = 0.17\text{mm}$
 $\Delta z = -14\text{mm}$

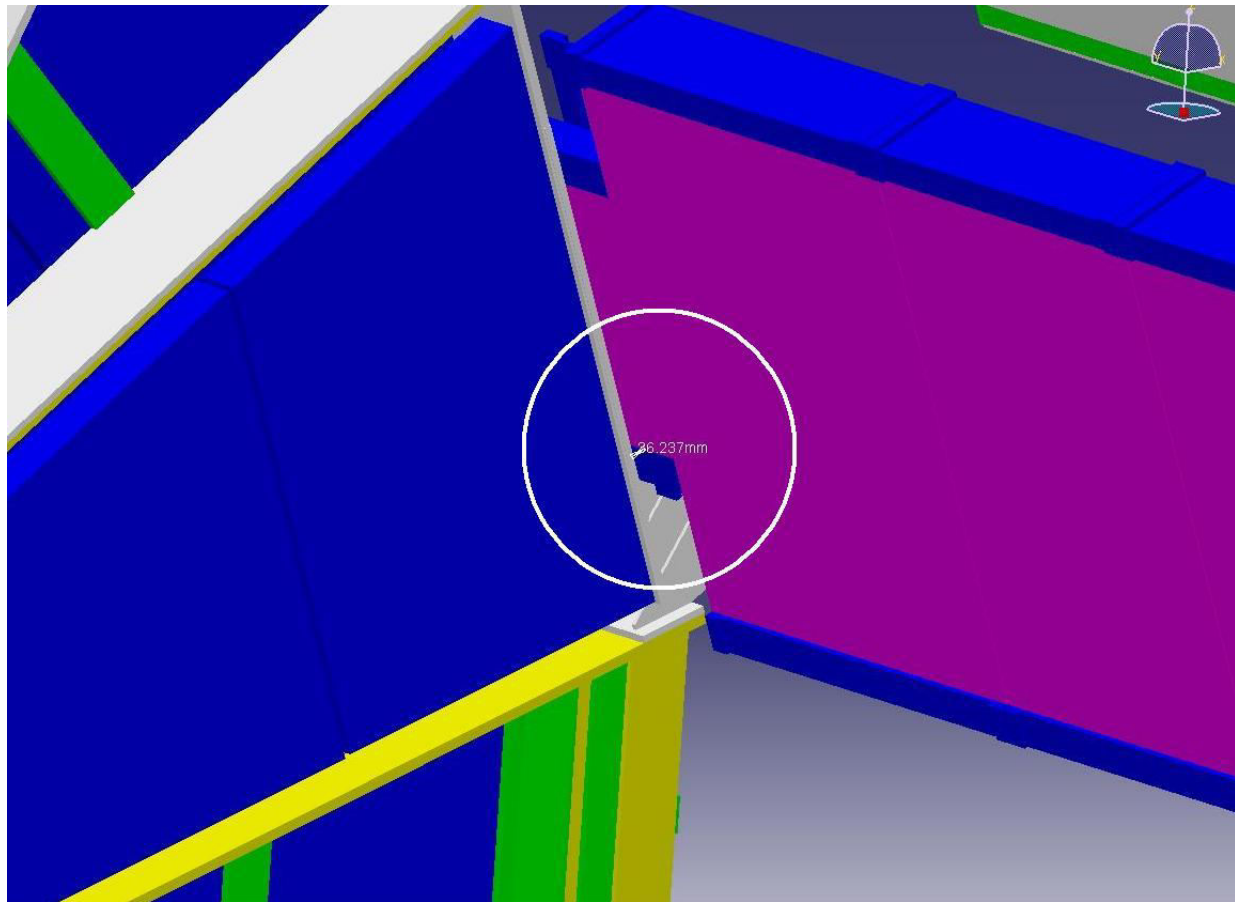

AT602154MQ - MUON BARREL CHAMBERS DETAILED, SECTOR 2	NSM_0014 - BT HEATER BOXES AND CABLES - FOR SEC 2,4,6,8,10	Clearance	30.285	Not Relevant
---	---	-----------	--------	--------------

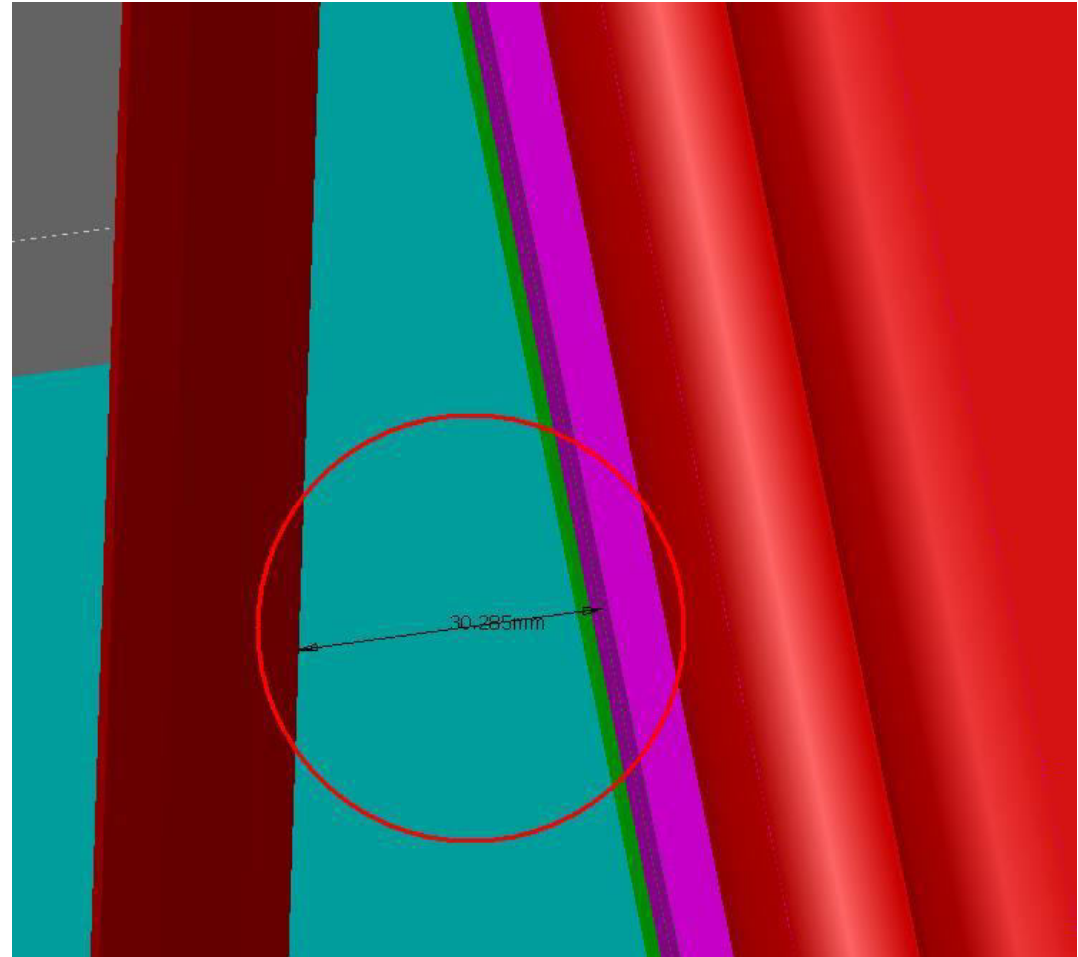
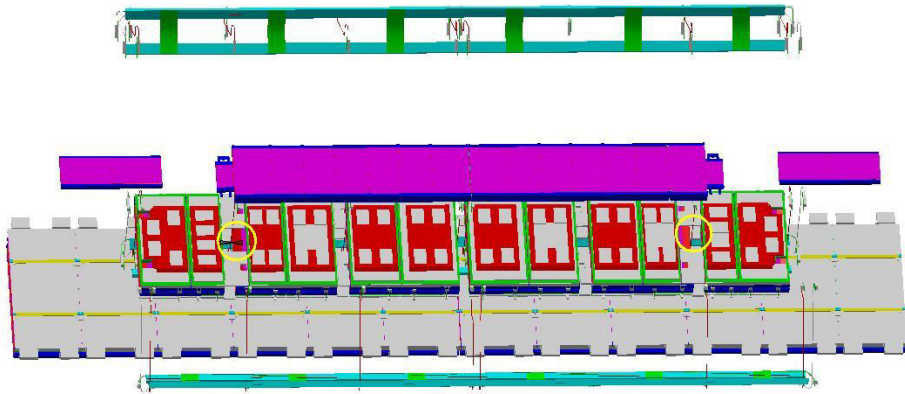

SIDE A-C

Sector 2

AT602154MQ - MUON BARREL CHAMBERS DETAILED, SECTOR 2	NTB_0001 BT2 - TB STANDARD COIL - SECTOR 2	Clearance	23.2737	Not Relevant
---	---	-----------	---------	--------------

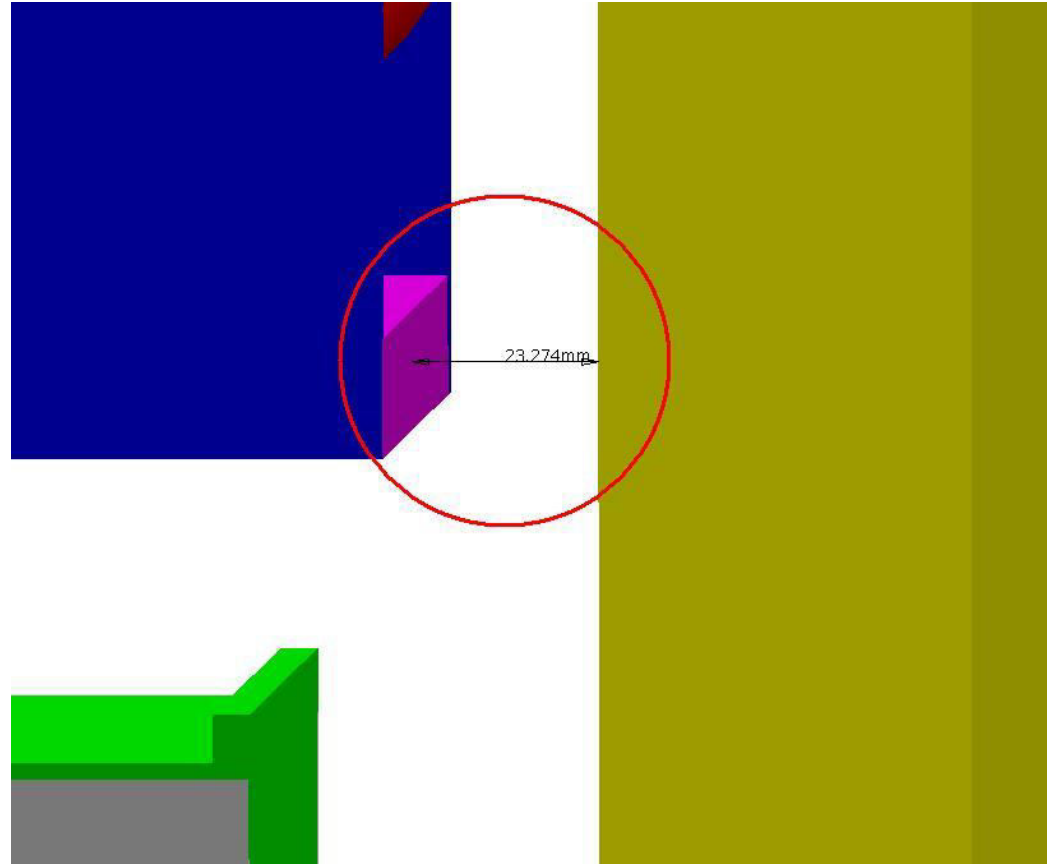
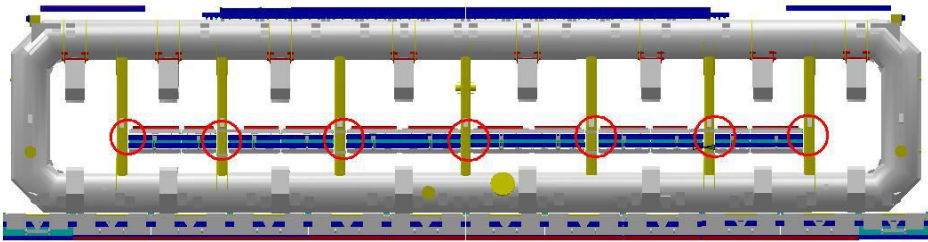

SIDE A-C

Sector 2

RELEVANT

AT602154MQ - MUON BARREL CHAMBERS DETAILED, SECTOR 2	NTB_0008 - TB CRYORING TOP SECTORS - (1, 3, 5, 7, 9)	Clearance	48.6848	Relevant
--	--	-----------	---------	----------

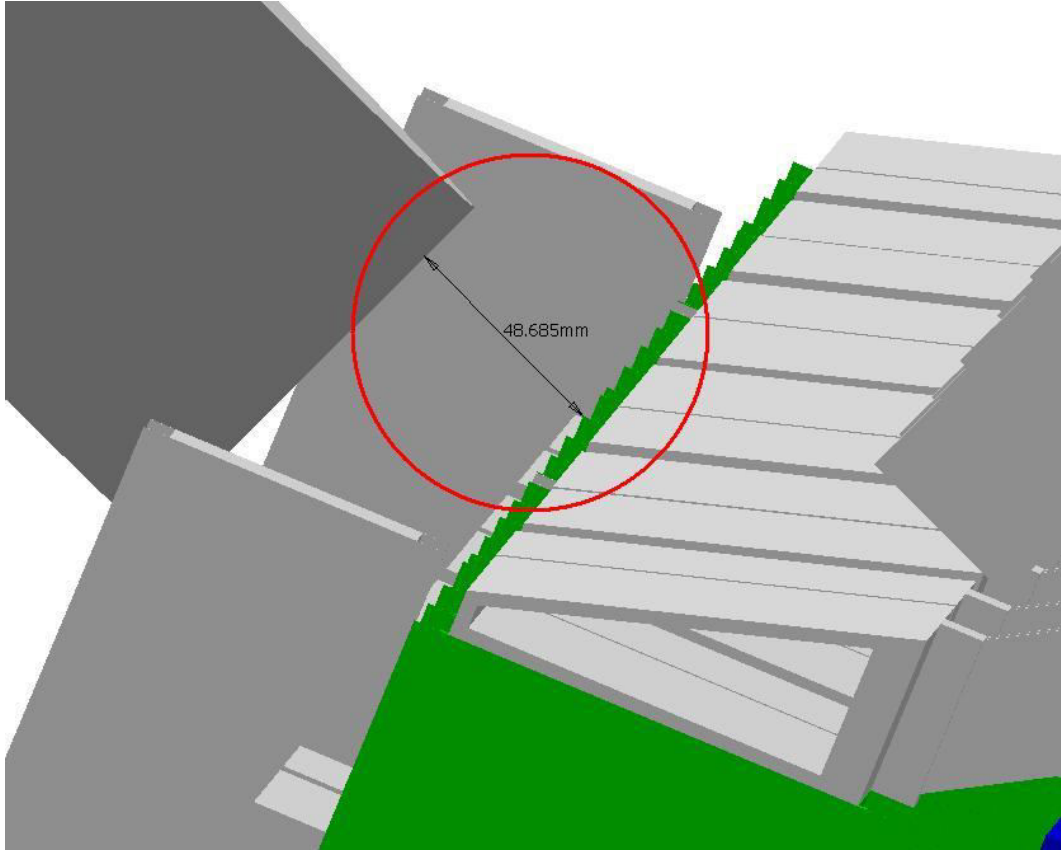
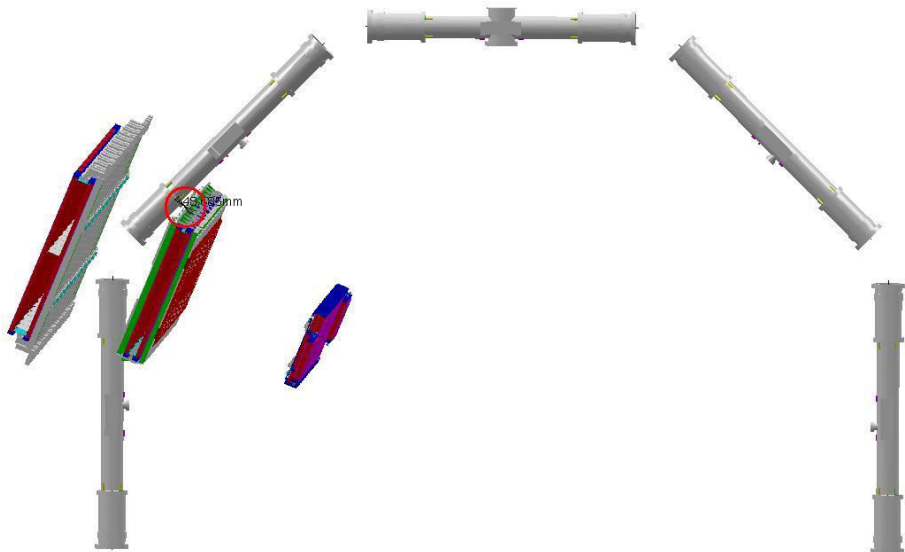

SIDE C

Sector 2