

# Clash Publish



Clash Computation Specification			
Products Selected		Value	Status
AT602154MQ - MUON BARREL CHAMBERS DETAILED, SECTOR 2	NMA_0001 - BARREL PROJECTIVE ALIGNMENT. - SIMPLE 3-D MODEL. SECTOR 1	-1.9	Relevant
	NMA_0002 - BARREL PROJECTIVE ALIGNMENT. - SIMPLE 3-D MODEL. SECTOR 3	-1.9	Relevant
	NMA_0009 - END CAP ALIGNMENT SIDE "A". - SIMPLE 3-D MODEL.	732.9	Relevant
	NMA_0010 - END CAP ALIGNMENT SIDE "C" - SIMPLE 3-D MODEL	-743.8	Relevant
	NMA_0011 - SECTOR 02 SIDE C (A) - REFERENCE ALIGNMENT SYSTEM AND	-166.4	Relevant
	ZTB_0002 - GLOBAL TB ENVELOPE (8 COILS)	-0.6	Relevant
	Z5_0002 - Z5 GLOBAL ENVELOPE (SIDE A) - AND LOCATION INTERFACES	-123.6	Not Relevant
	Z5_0001 - Z5 GLOBAL ENVELOPE (SIDE C) - AND LOCATION INTERFACES - Working on new version	-123.6	Not Relevant

Revised with Olga 1/06/2005

Revised with Tatiana 9/06/2005

AT602154MQ - MUON BARREL CHAMBERS DETAILED, SECTOR 2	NMA_0001 - BARREL PROJECTIVE ALIGNMENT. - SIMPLE 3-D MODEL. SECTOR 1	Clash	-1.9324	Relevant
--	--	-------	---------	----------

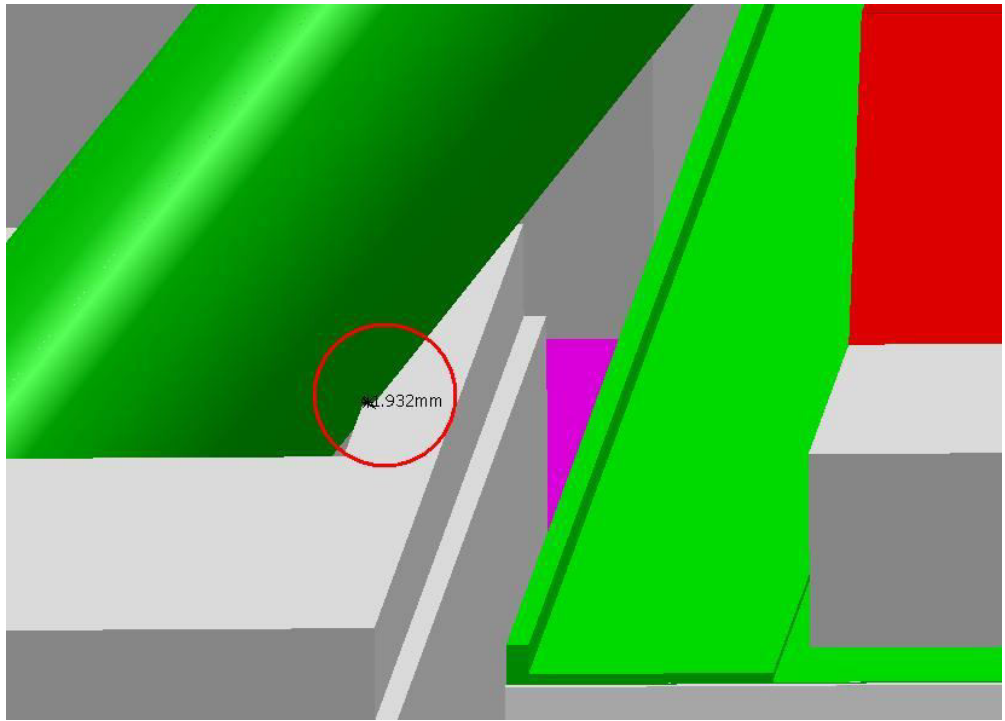
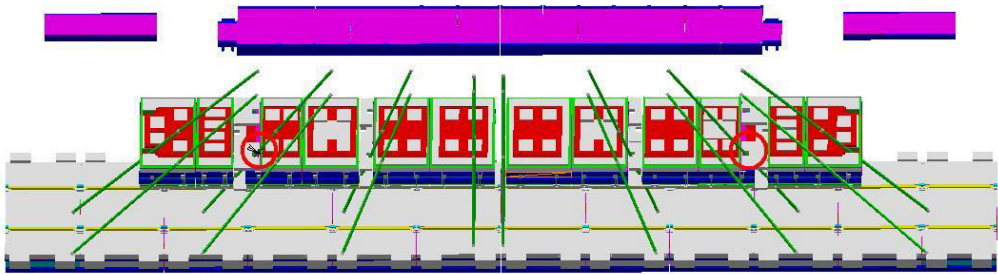

Clash value: ~1.9 mm

SIDE A-C

Sector 2

RELEVANT

# Clash View:

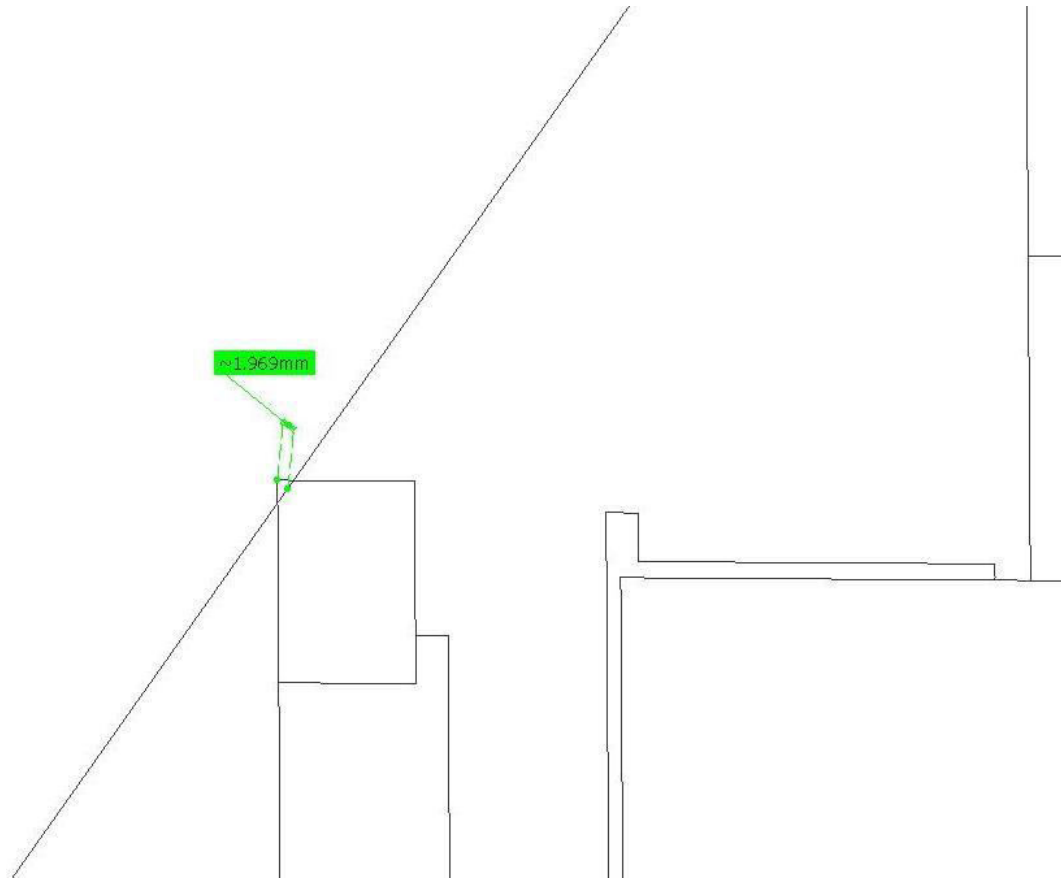
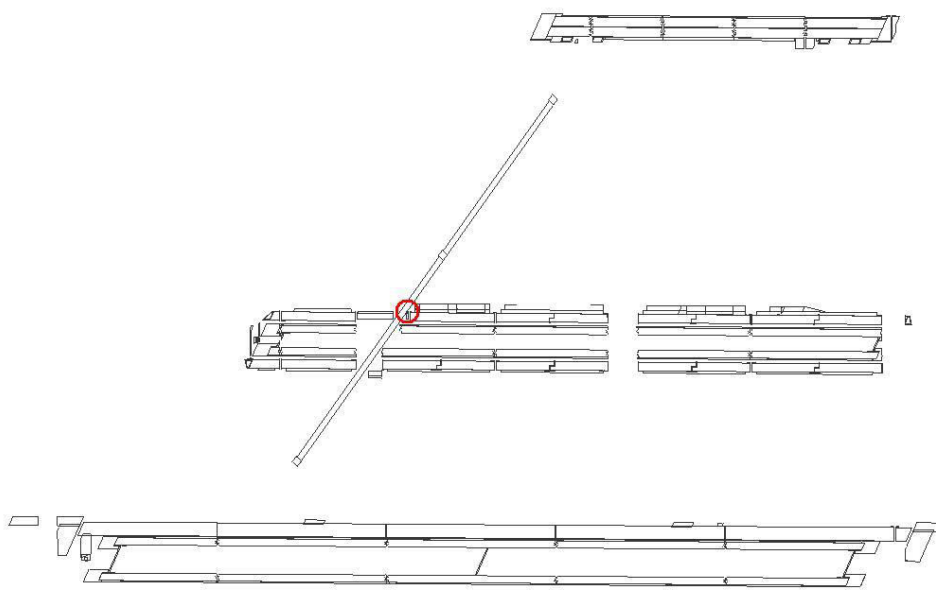
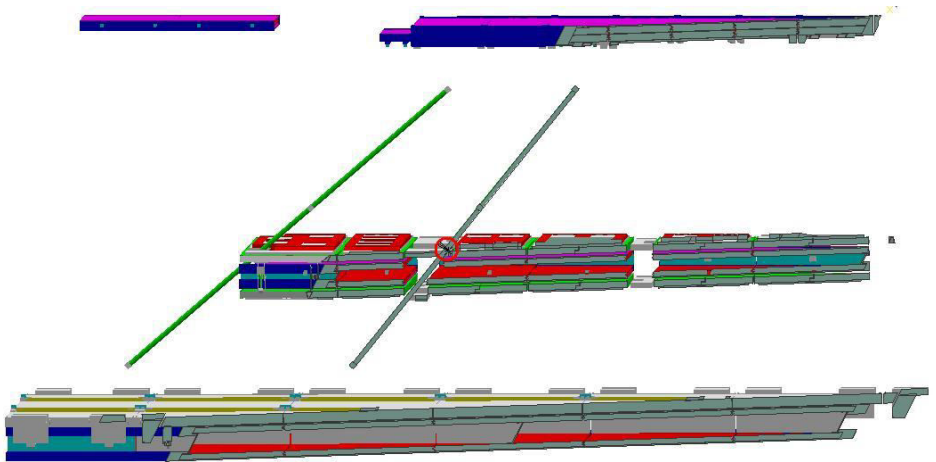

AT602154MQ - MUON BARREL CHAMBERS DETAILED, SECTOR 2	NMA_0002 - BARREL PROJECTIVE ALIGNMENT. - SIMPLE 3-D MODEL. SECTOR 3	Clash	-1.9383	Relevant
--	--	-------	---------	----------

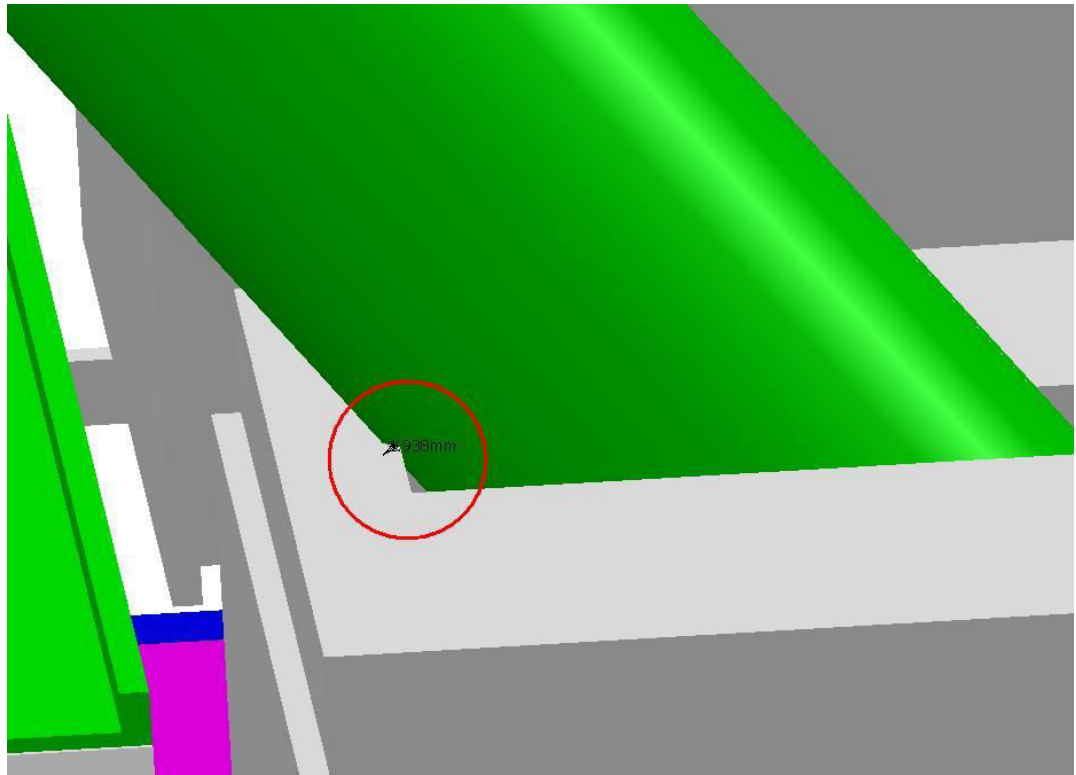
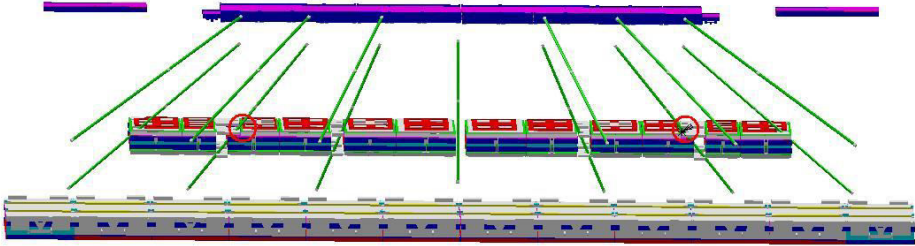

Clash value: ~ 1.9 mm

SIDE A-C

Sector 2

RELEVANT

# Clash View:

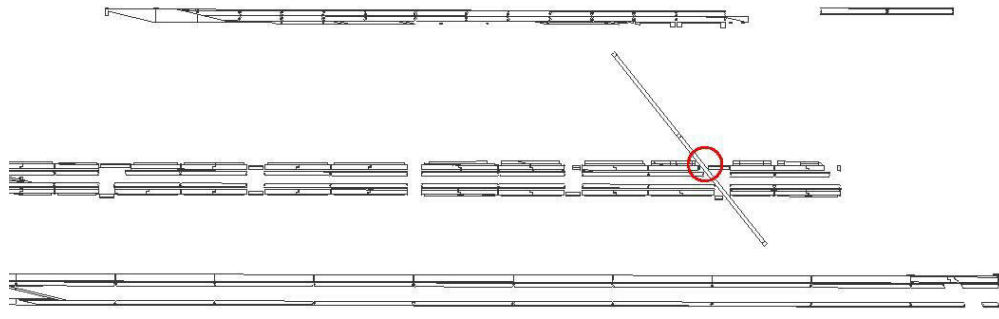
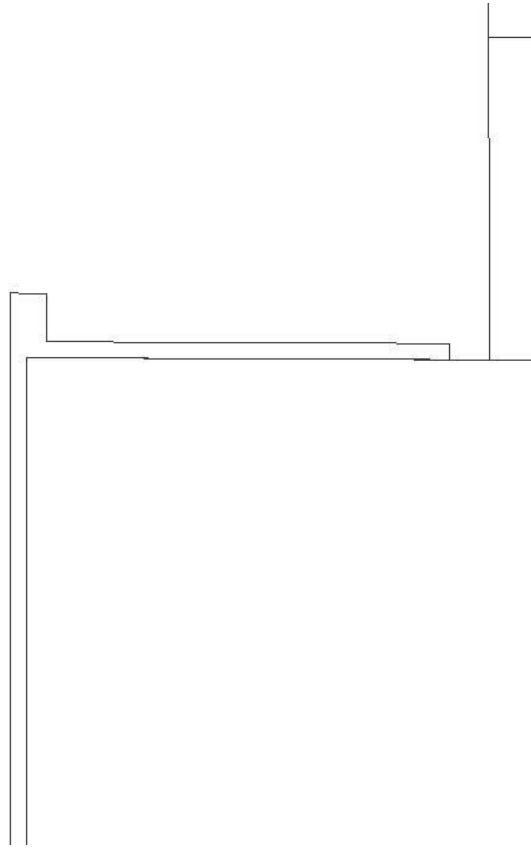
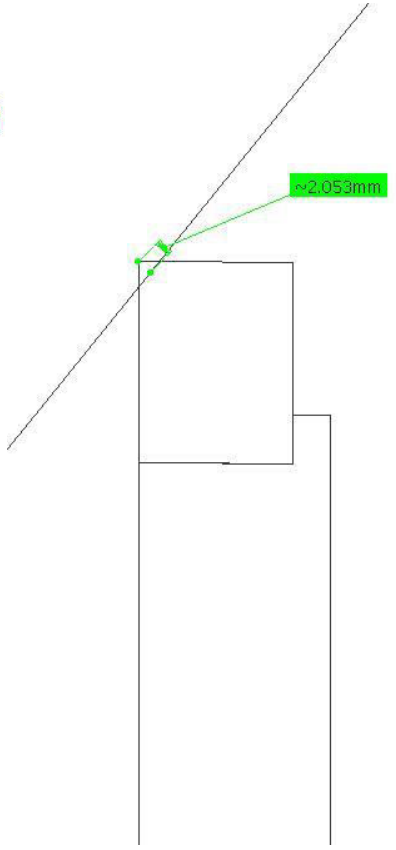
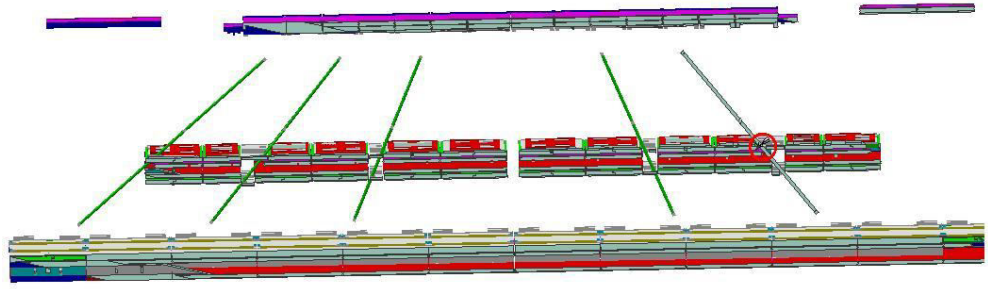

AT602154MQ - MUON BARREL  
CHAMBERS DETAILED, SECTOR 2

NMA\_0009 - END CAP ALIGNMENT SIDE "A". -  
SIMPLE 3-D MODEL

Clash

-732.912

Relevant

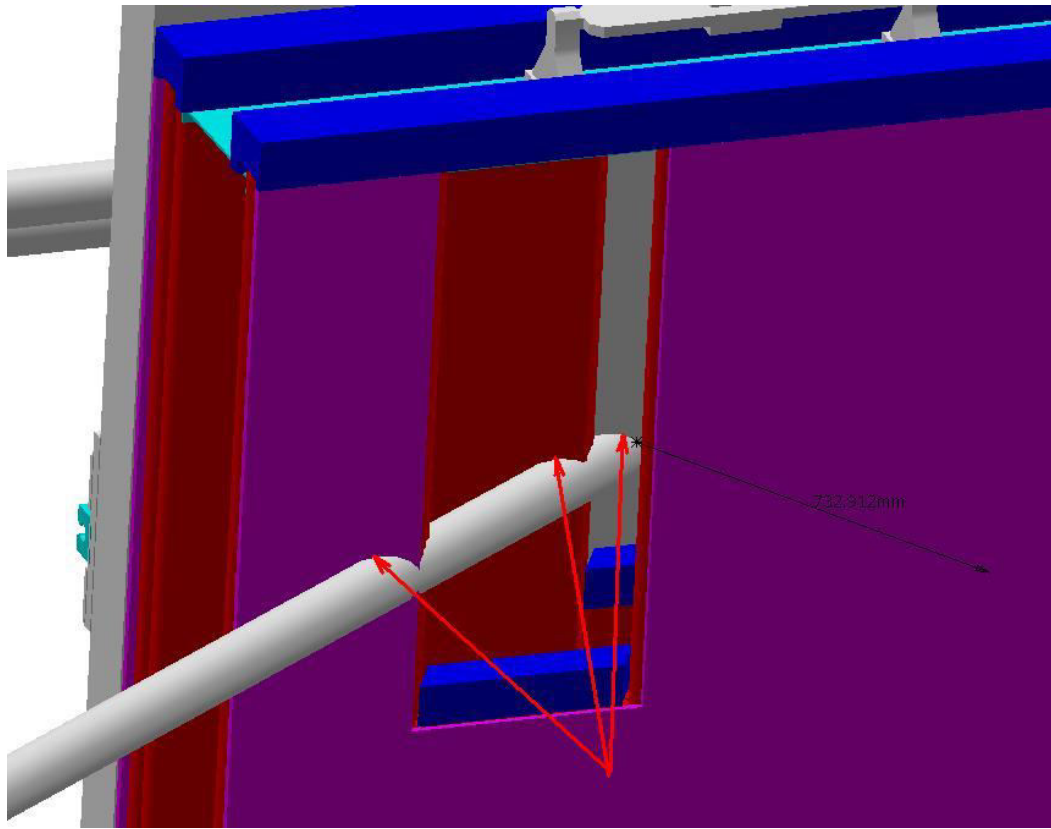
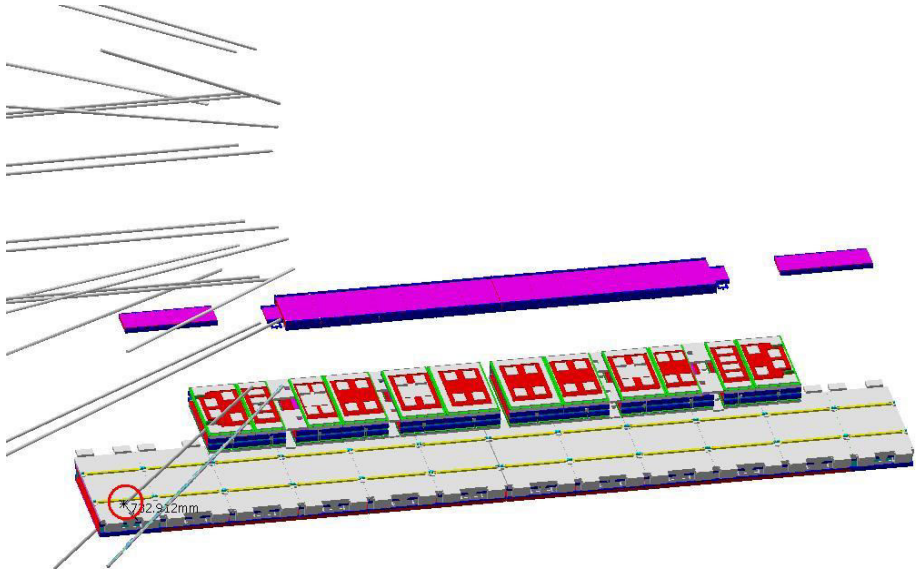

Clash value: ~ 732.9 mm

SIDE A

Sector 2

RELEVANT

# Clash View:

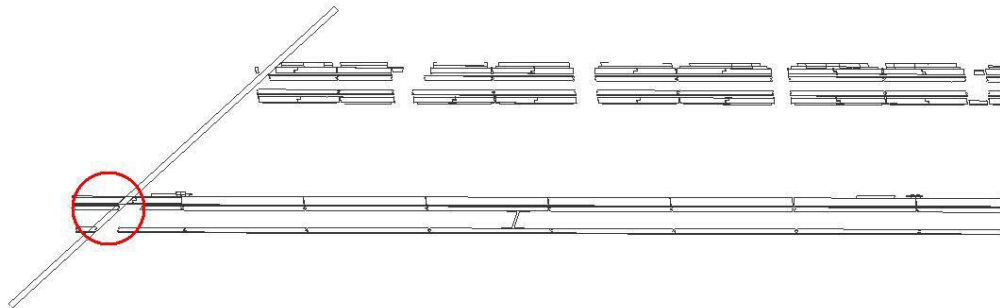
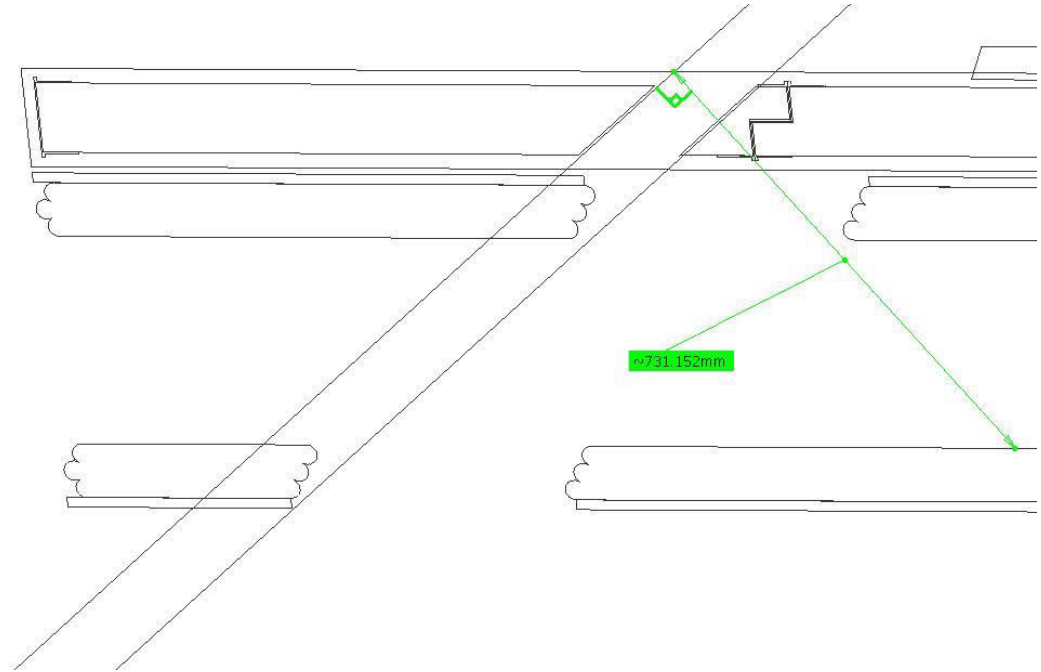
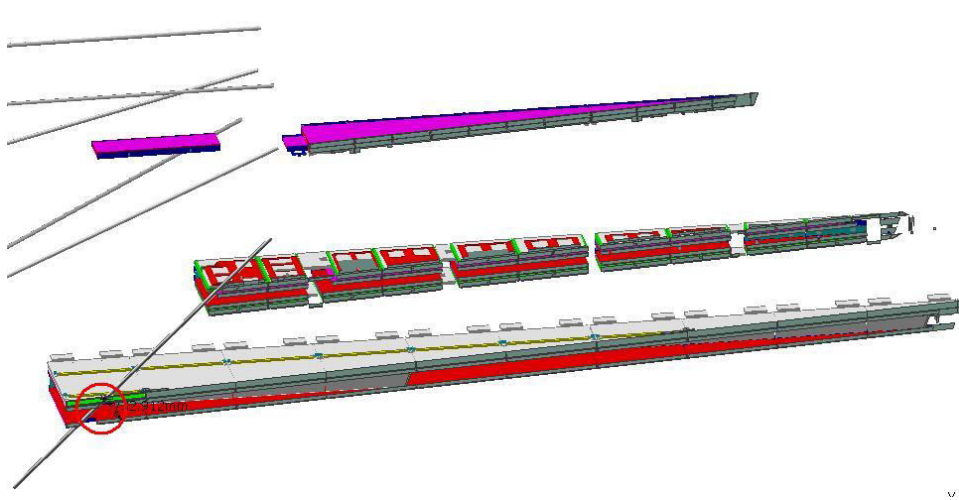

AT602154MQ - MUON BARREL CHAMBERS DETAILED, SECTOR 2	NMA_0010 - END CAP ALIGNMENT SIDE "C" - SIMPLE 3-D MODEL	Clash	-743.785	Relevant
---	---	-------	----------	----------

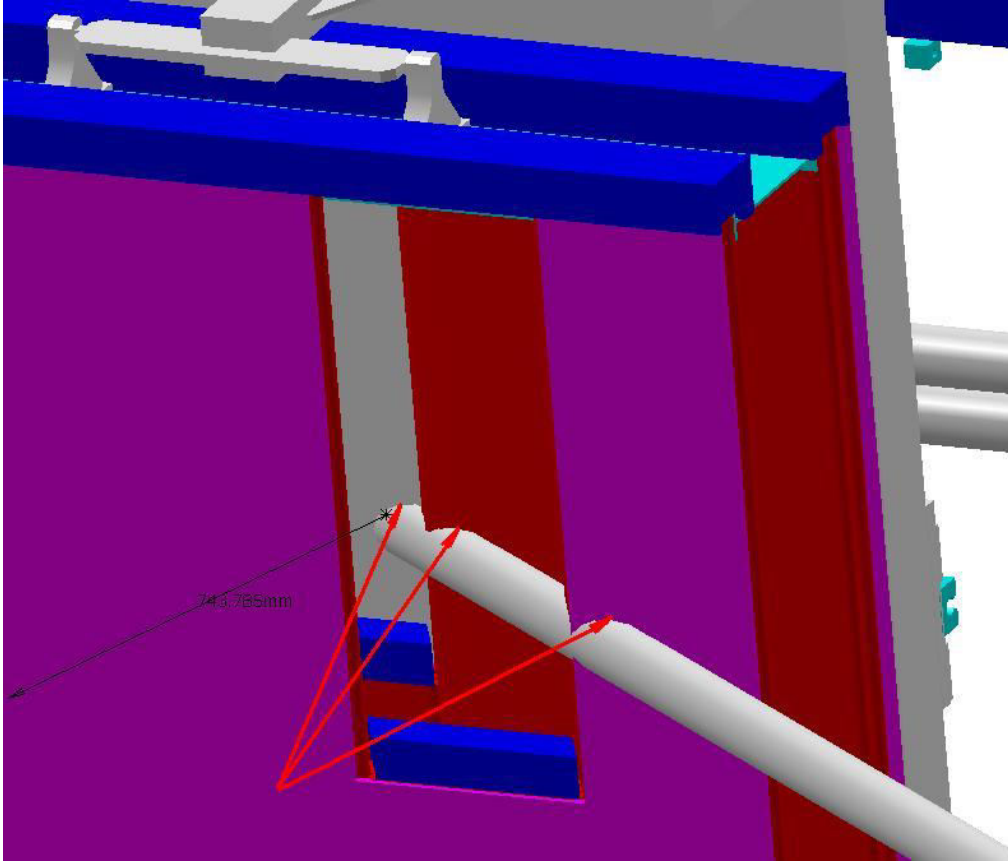
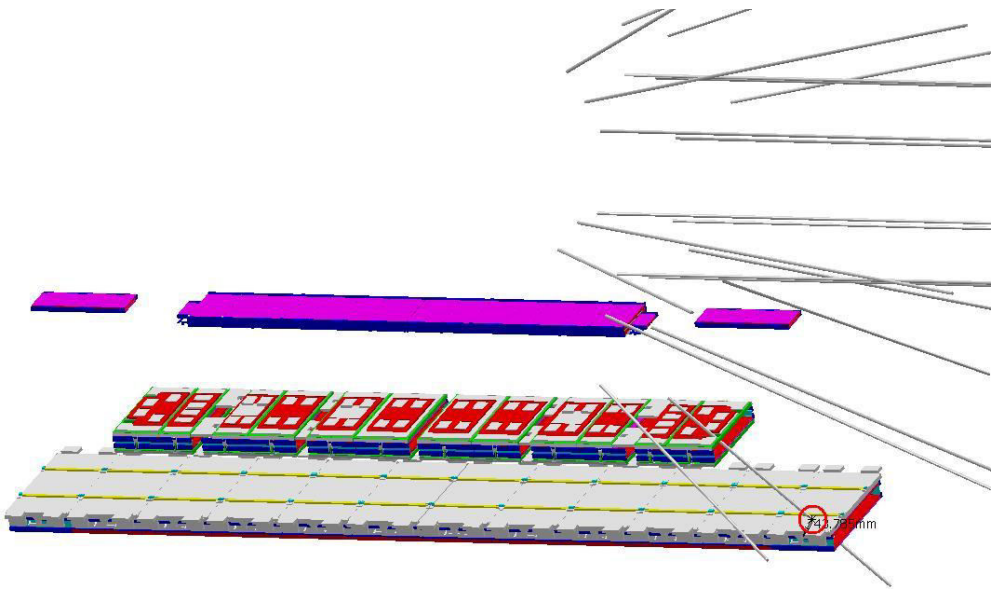

Clash value: ~743.8 mm

SIDE C

Sector 2



# Clash View:

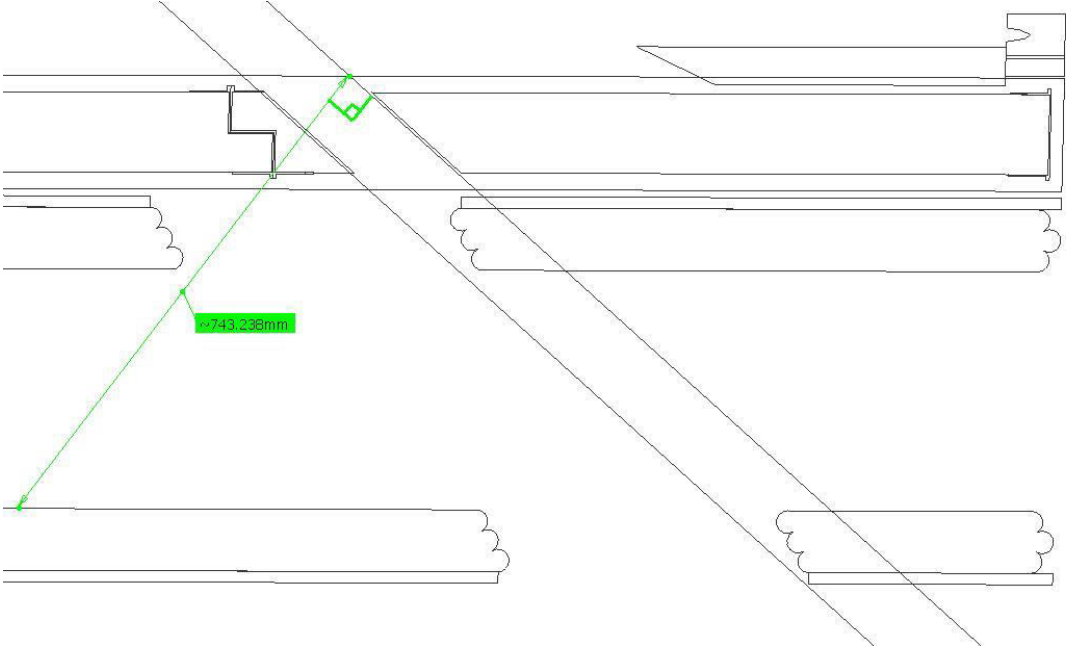
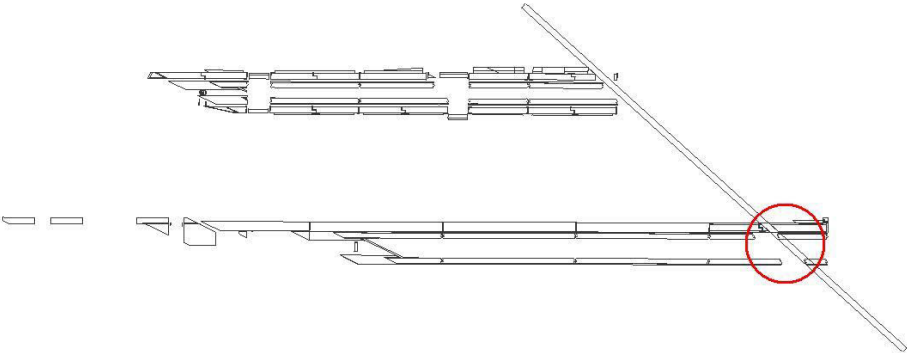
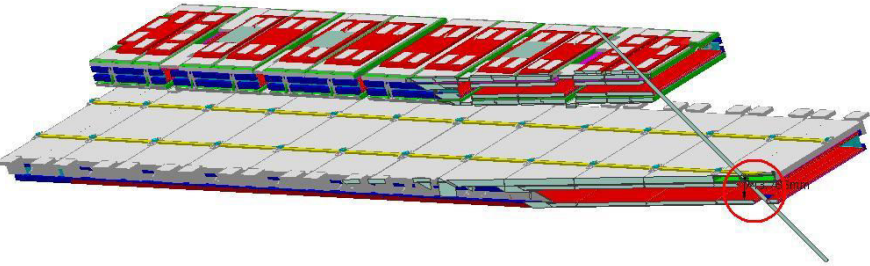
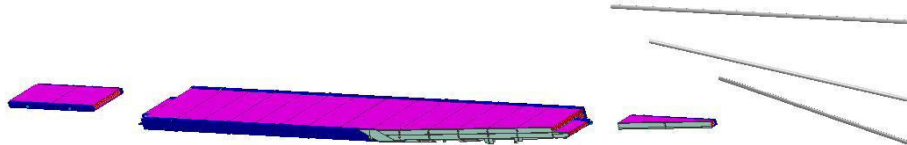

AT602154MQ - MUON BARREL CHAMBERS DETAILED, SECTOR 2	NMA_0011 - SECTOR 02 SIDE C (A) - REFERENCE ALIGNMENT SYSTEM AND	Clash	-166.435	Relevant
--	--	-------	----------	----------

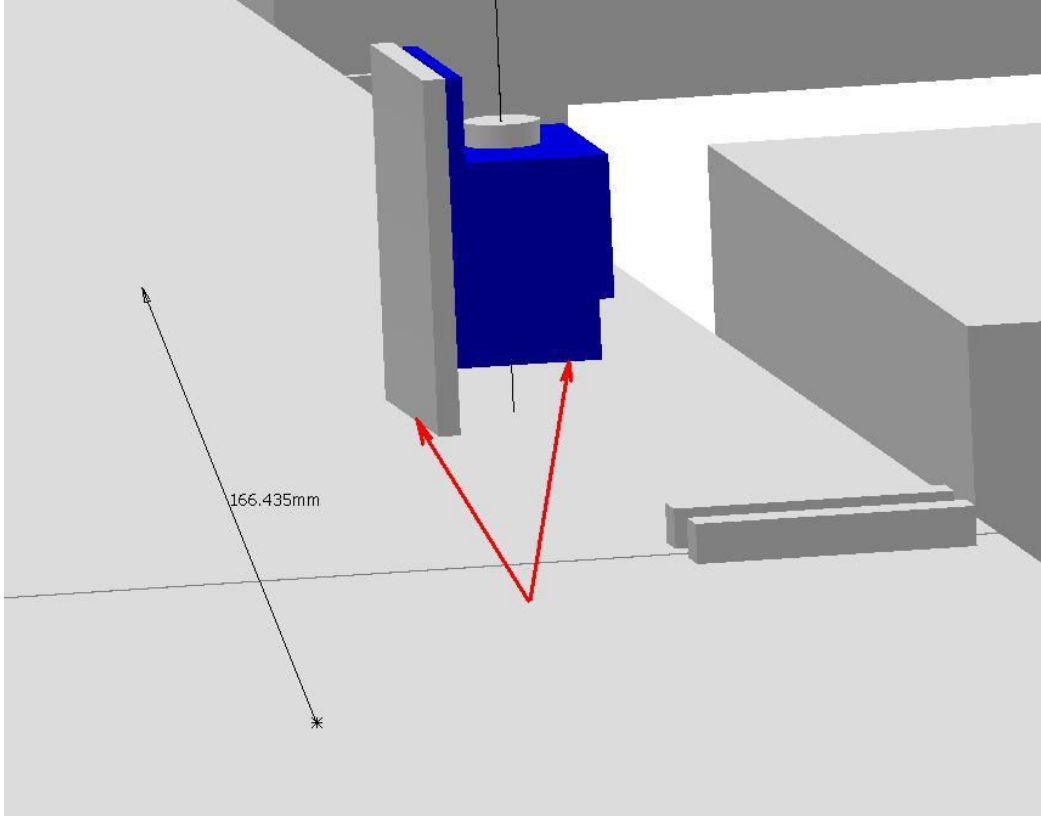
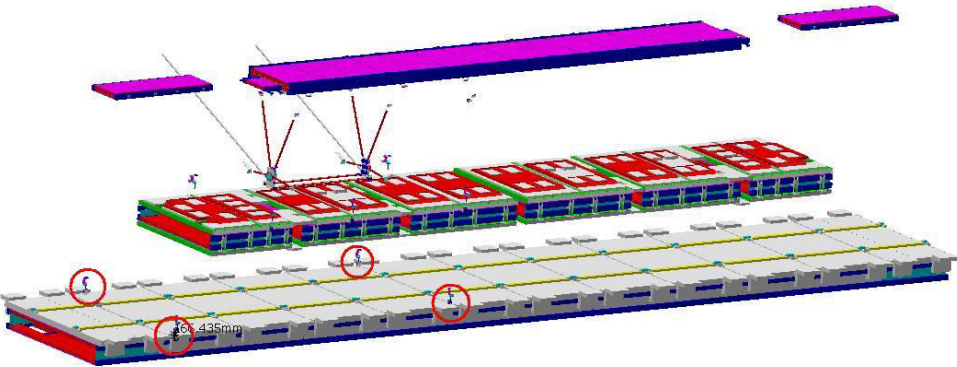

Clash value: ~166.4 mm

SIDE C

Sector 2

RELEVANT

# Clash View:

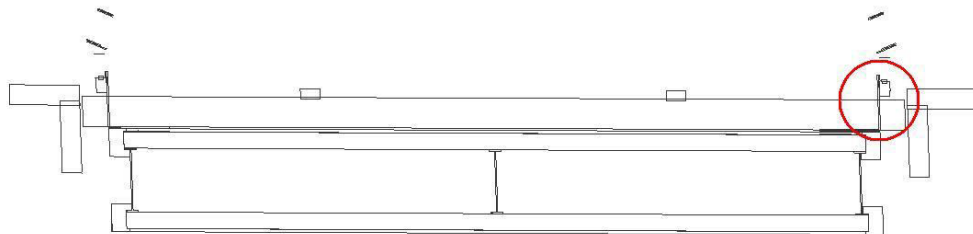
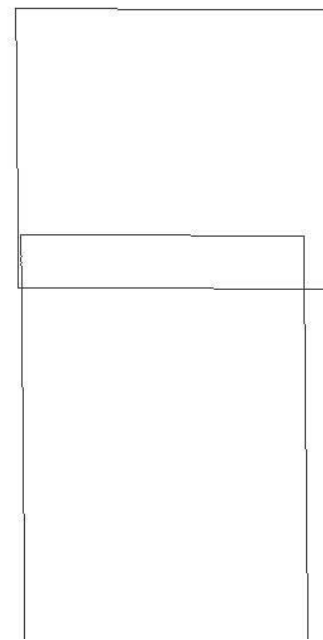
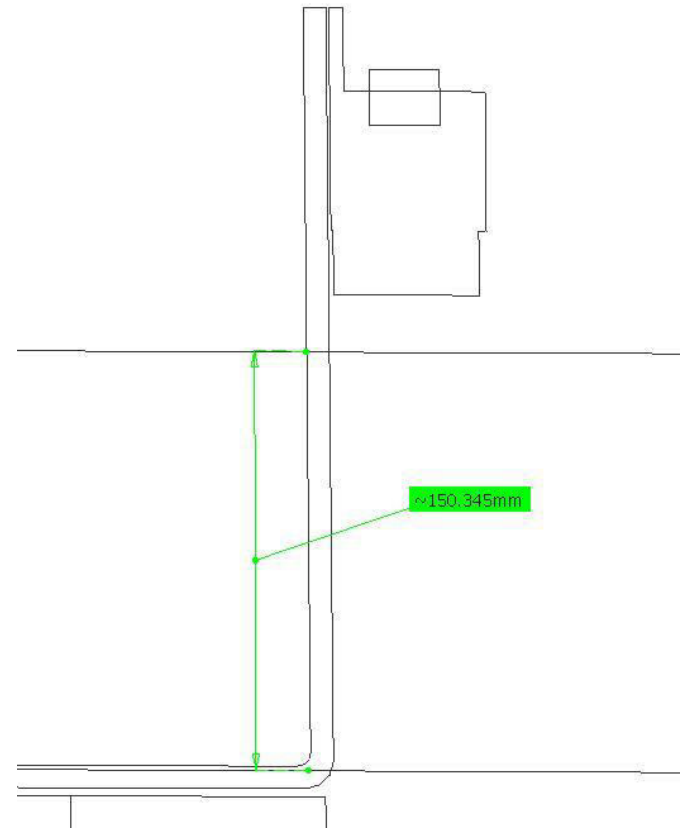
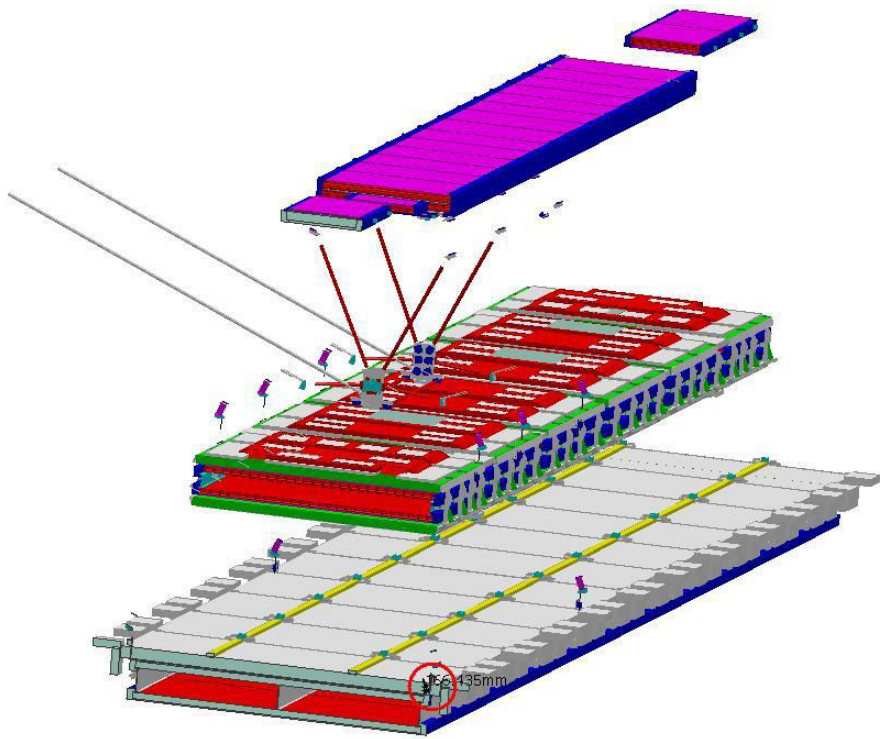

AT602154MQ - MUON BARREL  
CHAMBERS DETAILED, SECTOR 2

Z5\_0002 - Z5 GLOBAL ENVELOPE (SIDE A) - AND  
LOCATION INTERFACES

Clash

-123.649

Not Relevant

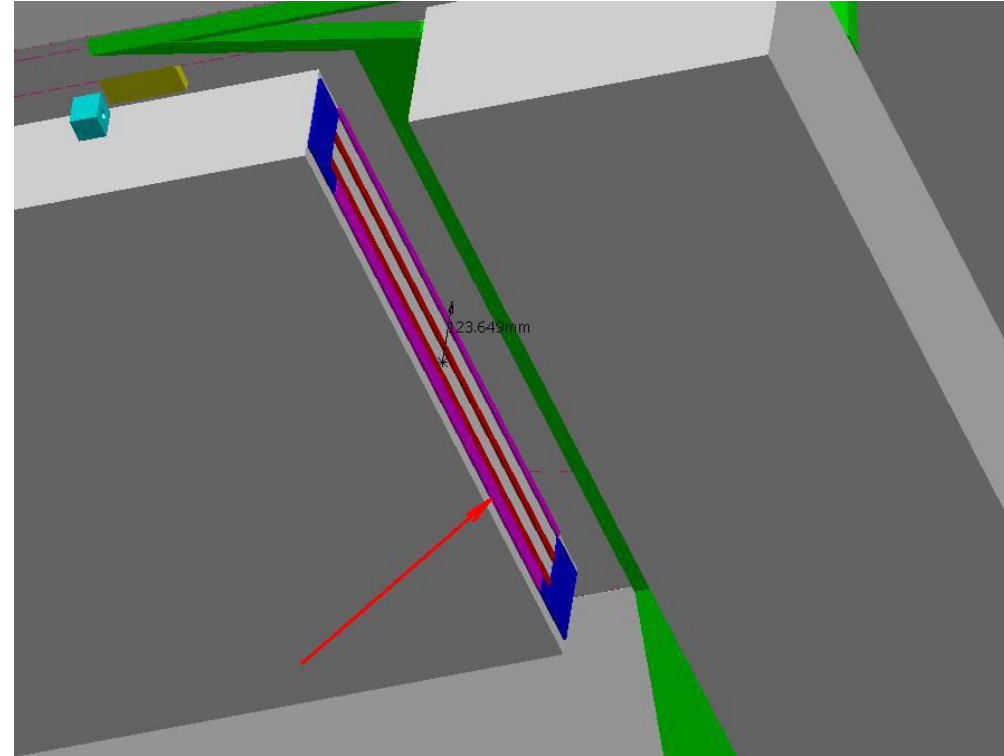
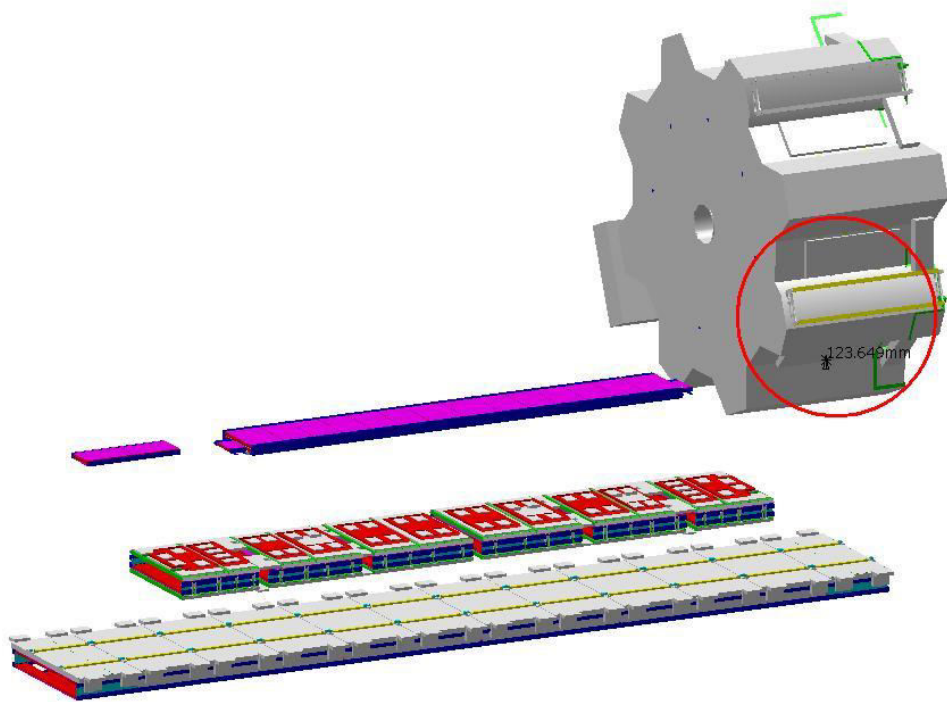

Clash value: ~ -123.6 mm

SIDE A

Sector 2

# Clash View:

